



Brackets



Global Experts in Orthodontics

03

GC Orthodontics
GLOBAL EXPERTS IN ORTHODONTICS

Brackets

RHODIUM Brackets and Auxillaries	5
EXPERIENCE™ Metal Self-Ligating	11
EXPERIENCE™ Ceramic Self-Ligating	16
EXPERIENCE™ Mini Ceramic Self-Ligating	20
EXPERIENCE™ Lingual Self-Ligating	22
CHIC Ceramic Twin	26
CHIC with Legend Rhodium	29
LEGEND Mini Twin	30
LEGEND Mini V-Slot	38
LEGEND Mini Single Wing	40
LEGEND Medium Twin	42
LEGEND Medium V-Slot	48
LEGACY/LEGACY Mini Twin	50
AXCESS Twin	53
Standard Edgewise/Begg	55
Weldable Brackets	57



RHODIUM

A Perfect Symmetry of Aesthetics & Performance

GC Orthodontics is proud to introduce the industry's first complete Rhodium System, which includes self-ligating and twin brackets, archwires and auxiliaries. It is the first fully aesthetic metal system in the world.

Since TOMY, our manufacturing partner, first introduced their interactive self-ligating brackets, many companies have followed. At GC Orthodontics, however, our goals are different. We strive to constantly innovate and improve, not simply copy. With the introduction of Experience C, our self-ligating ceramic bracket system, and its exclusive rhodium treated clip, we have been exploring other applications for this unique technology, which has led to our exclusive development of the Rhodium System.

There are many facets to our system; the most obvious is aesthetics - the Rhodium brackets and wires reflect light and blend with dentition to give your patients a metal appliance that is virtually unnoticeable. The clinical advantages are obvious, eliminating the concern of using ceramic brackets on lower teeth, and offsetting the limitations of aligner treatment.

Our Rhodium wires are the perfect complement to our brackets. Unlike other aesthetic wires, the unique rhodium treatment process is not a coating, therefore the appearance is permanent. This is true of our Rhodium brackets and auxiliaries as well.

EXPERIENCE metal
Rhodium



LEGEND
Rhodium



Rh Rhodium



EXPERIENCE

RHODIUM

EXPERIENCE RHODIUM Roth



Maxillary				Part Numbers				Notes
Tooth	Torque	Angulation	Rotation	018R	018L	022R	022L	
U1	12°	5°	0°	19-1110-0010	19-1210-0010	19-2110-0010	19-2210-0010	
U2	8°	9°	0°	19-1120-0010	19-1220-0010	19-2120-0010	19-2220-0010	
U3	-2°	13°	4°m	—	—	19-2130-0010	19-2230-0010	
U3/Hk	-2°	13°	4°m	19-113D-0010	19-123D-0010	19-213D-0010	19-223D-0010	Hk Distal
U3/Hk(Opt)	-2°	10°	4°m	—	—	19-213D-0012	19-223D-0012	Hk Distal
U4-5	-7°	0°	2°d	19-1140-0010	19-1240-0010	19-2140-0010	19-2240-0010	
U4-5/Hk	-7°	0°	2°d	19-114D-0010	19-124D-0010	19-214D-0010	19-224D-0010	Hk Distal

Mandibular				Part Numbers				Notes
Tooth	Torque	Angulation	Rotation	018R	018L	022R	022L	
L1-2	-1°	2°	0°	19-1410-0010	19-1310-0010	19-2410-0010	19-2310-0010	Universal
L2/Hk	-1°	2°	0°	19-141D-0010	19-131D-0010	—	—	Hk Distal
L3	-11°	7°	2°m	—	—	19-2430-0010	19-2330-0010	
L3/Hk	-11°	7°	2°m	19-143D-0010	19-133D-0010	19-243D-0010	19-233D-0010	Hk Distal
L4	-17°	-1°	4°d	19-1440-0010	19-1340-0010	19-2440-0010	19-2340-0010	
L4/Hk	-17°	-1°	4°d	19-144D-0010	19-134D-0010	19-244D-0010	19-234D-0010	Hk Distal
L5	-22°	-1°	4°d	19-1450-0010	19-1350-0010	19-2450-0010	19-2350-0010	
L5/Hk	-22°	-1°	4°d	19-145D-0010	19-135D-0010	19-245D-0010	19-235D-0010	Hk Distal



Single Patient Kits				Part Numbers			Notes
Rx	Upper Arch	Lower Arch	Hooks	018	022		
Roth	5-5	5-5	3	19-1CC3-0010	19-2CC3-0010		Hooks on 3's only
Roth	5-5	5-5	3,4,5	19-1CC5-0010	19-2CC5-0010		Hooks on 3,4,5

EXPERIENCE RHODIUM XT

Maxillary				Part Numbers				Notes
Tooth	Torque	Angulation	Rotation	018R	018L	022R	022L	
U3/Hk	0°	8°	2°	—	—	19-213D-0030	19-223D-0030	XT

Mandibular				Part Numbers				Notes
Tooth	Torque	Angulation	Rotation	018R	018L	022R	022L	
L3/Hk	-3°	7°	2°	—	—	19-243D-0030	19-233D-0030	XT

Color Codes



The distal-gingival color code allows an identification of the bracket to prevent bonding errors. For some prescriptions, these color codes may be different on the bicuspid.

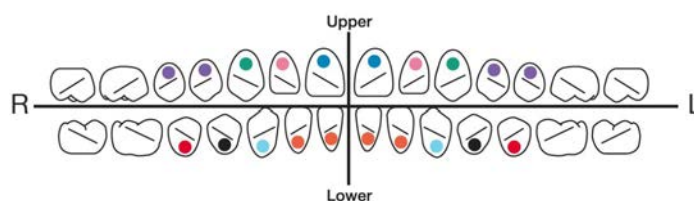



EXPERIENCE RHODIUM MBT



Maxillary				Part Numbers				Notes
Tooth	Torque	Angulation	Rotation	018R	018L	022R	022L	
U1	17°	4°	0°	19-1110-0020	19-1210-0020	19-2110-0020	19-2210-0020	
U2	10°	8°	0°	19-1120-0020	19-1220-0020	19-2120-0020	19-2220-0020	
U3	-7°	8°	0°	—	—	19-2130-0020	19-2230-0020	
U3/Hk	-7°	8°	0°	19-113D-0020	19-123D-0020	19-213D-0020	19-223D-0020	Hk Distal
U3/Hk(Opt)	0°	8°	0°	19-113D-0021	19-123D-0021	19-213D-0021	19-223D-0021	Hk Distal
U4	-7°	0°	0°	19-1540-0020	19-1540-0020	19-2540-0020	19-2540-0020	Universal
U4/Hk	-7°	0°	0°	19-114D-0020	19-124D-0020	19-214D-0020	19-224D-0020	Hk Distal
U5	-7°	0°	0°	19-1550-0020	19-1550-0020	19-2550-0020	19-2550-0020	Universal
U5/Hk	-7°	0°	0°	19-115D-0020	19-125D-0020	19-215D-0020	19-225D-0020	Hk Distal

Mandibular				Part Numbers				Notes
Tooth	Torque	Angulation	Rotation	018R	018L	022R	022L	
L1-2	-6°	0°	0°	19-1610-0020	19-1610-0020	19-2610-0020	19-2610-0020	Universal
L3	-6°	3°	0°	—	—	19-2430-0020	19-2330-0020	
L3/Hk	-6°	3°	0°	19-143D-0020	19-133D-0020	19-243D-0020	19-233D-0020	Hk Distal
L3/Hk(Opt)	0°	3°	0°	19-143D-0021	19-133D-0021	19-243D-0021	19-233D-0021	Hk Distal
L4	-12°	2°	0°	19-1440-0020	19-1340-0020	19-2440-0020	19-2340-0020	
L4/Hk	-12°	2°	0°	19-144D-0020	19-134D-0020	19-244D-0020	19-234D-0020	Hk Distal
L5	-17°	2°	0°	19-1450-0020	19-1350-0020	19-2450-0020	19-2350-0020	
L5/Hk	-17°	2°	0°	19-145D-0020	19-135D-0020	19-245D-0020	19-235D-0020	Hk Distal



Single Patient Kits				Part Numbers		Notes
Rx	Upper Arch	Lower Arch	Hooks	018	022	
MBT	5-5	5-5	3	19-1CC3-0020	19-2CC3-0020	Hooks on 3's only
MBT	5-5	5-5	3,4,5	19-1CC5-0020	19-2CC5-0020	Hooks on 3,4,5

Color Codes



The distal-gingival color code allows an identification of the bracket to prevent bonding errors. For some prescriptions, these color codes may be different on the bicuspid.

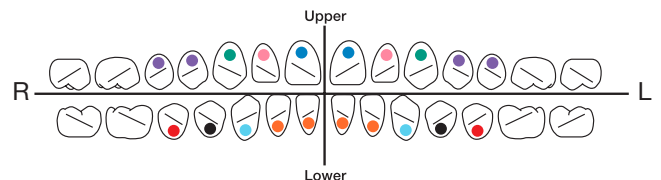

LEGEND

RHODIUM



Microetched 80 gauge mesh for superior retention



Large undercuts for easy ligation. Low Profile torque in base design.



LEGEND MINI RHODIUM Roth

Maxillary				Part Numbers				Notes
Tooth	Torque	Angulation	Rotation	018R	018L	022R	022L	
U1	12°	5°	0°	38-1110-0010	38-1210-0010	38-2110-0010	38-2210-0010	
U2	8°	9°	0°	38-1120-0010	38-1220-0010	38-2120-0010	38-2220-0010	
U3/Hk	-2°	10°	4°m	38-113D-0010	38-123D-0010	38-213D-0010	38-223D-0010	Hk Distal
U4-5	-7°	0°	2°d	38-1140-0010	38-1240-0010	38-2140-0010	38-2240-0010	
U4-5/Hk	-7°	0°	2°d	38-114M-0010	38-124M-0010	38-214M-0010	38-224M-0010	Hk Mesial
U4-5/OB	-7°	0°	0°	38-1540-0013	38-1540-0013	38-2540-0013	38-2540-0013	Offset Base/Universal
U4-5/OB/Hk	-7°	0°	0°	38-114M-0013	38-124M-0013	38-214M-0013	38-224M-0013	Offset Base/Hk Mesial

Mandibular				Part Numbers				Notes
Tooth	Torque	Angulation	Rotation	018R	018L	022R	022L	
L1-2	-1°	0°	0°	38-1610-0010	38-1610-0010	38-2610-0010	38-2610-0010	Universal
L3/Hk	-11°	7°	2°m	38-143D-0010	38-133D-0010	38-243D-0010	38-233D-0010	Hk Distal
L4	-17°	-1°	4°d	38-1440-0010	38-1340-0010	38-2440-0010	38-2340-0010	
L4/Hk	-17°	1°	4°d	38-144D-0010	38-134D-0010	38-244D-0010	38-234D-0010	Hk Distal
L5	-22°	1°	4°d	38-1450-0010	38-1350-0010	38-2450-0010	38-2350-0010	
L5/Hk	-22°	-1°	4°d	38-145D-0010	38-135D-0010	38-245D-0010	38-235D-0010	Hk Distal
L4/OB	-17°	0°	0°	38-1640-0013	38-1640-0013	38-2640-0013	38-2640-0013	Offset Base/Universal
L4/OB/Hk	-17°	0°	0°	38-144D-0013	38-134D-0013	38-244D-0013	38-234D-0013	Offset Base/Hk Distal
L5/OB	-22°	0°	0°	38-1650-0013	38-1650-0013	38-2650-0013	38-2650-0013	Offset Base/Universal
L5/OB/Hk	-22°	0°	0°	38-145D-0013	38-135D-0013	38-245D-0013	38-235D-0013	Offset Base/Hk Distal

Single Patient Kits				Part Numbers		Notes
Rx	Upper Arch	Lower Arch	Hooks	018	022	
Roth	5-5	5-5	3	38-1CC3-0010	38-2CC3-0010	Hooks on 3's only
Roth	5-5	5-5	U3, L3,4	38-1C34-0010	38-2C34-0010	Hooks on U3, L3,4
Roth	5-5	5-5	3,4,5	38-1CC5-0010	38-2CC5-0010	Hooks on 3,4,5

Color Codes

The distal-gingival color code allows an identification of the bracket to prevent bonding errors. For some prescriptions, these color codes may be different on the bicuspid.

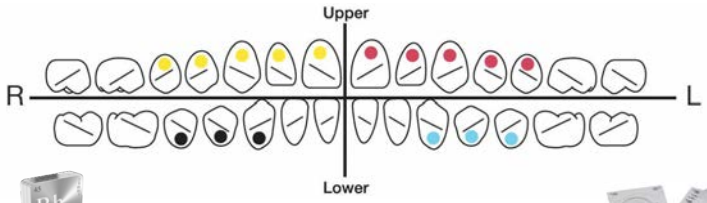

NEW!

V-Slot
Vertical Slot Bracket System
Now available in Rhodium!

Rhodium Treated Archwires

Rhodium treated Niti and Stainless Steel wire complete a totally aesthetic metal bracket system that will provide the beauty of an aesthetic appliance with the convenience of treating with metal braces. Rhodium archwires can be found on [page 97 and 101](#) of this catalog.



LEGEND MINI RHODIUM MBT

Maxillary				Part Numbers				Notes
Tooth	Torque	Angulation	Rotation	018R	018L	022R	022L	
U1	17°	4°	0°	38-1110-0020	38-1210-0020	38-2110-0020	38-2210-0020	
U2	10°	8°	0°	38-1120-0020	38-1220-0020	38-2120-0020	38-2220-0020	
U3/Hk	-7°	8°	0°	38-113D-0020	38-123D-0020	38-213D-0020	38-223D-0020	Hk Distal
U4-5	-7°	0°	0°	38-1540-0020	38-1540-0020	38-2540-0020	38-2540-0020	Universal
U4-5/Hk	-7°	0°	0°	38-114D-0020	38-124D-0020	38-214D-0020	38-224D-0020	Hk Distal
U5	-7°	0°	0°	38-1550-0020	38-1550-0020	38-2550-0020	38-2550-0020	Universal
U4-5/OB	-7°	0°	0°	38-1540-0013	38-1540-0013	38-2540-0013	38-2540-0013	Offset Base/Universal
U4-5/OB/Hk	-7°	0°	0°	—	—	38-214D-0073	38-224D-0073	Offset Base/Hk Distal

Mandibular				Part Numbers				Notes
Tooth	Torque	Angulation	Rotation	018R	018L	022R	022L	
L1-2	-6°	0°	0°	38-1610-0020	38-1610-0020	38-2610-0020	38-2610-0020	Universal
L3/Hk	-6°	3°	0°	38-143D-0020	38-133D-0020	38-243D-0020	38-233D-0020	Hk Distal
L4	-12°	2°	0°	38-1440-0020	38-1340-0020	38-2440-0020	38-2340-0020	
L4/Hk	-12°	2°	0°	38-144D-0020	38-134D-0020	38-244D-0020	38-234D-0020	Hk Distal
L5	-17°	2°	0°	38-1450-0020	38-1350-0020	38-2450-0020	38-2350-0020	
L5/Hk	-17°	2°	0°	38-145D-0020	38-135D-0020	38-245D-0020	38-235D-0020	Hk Distal
L4/OB	-12°	2°	0°	38-1440-0073	38-1340-0073	38-2440-0073	38-2340-0073	Offset Base
L4/OB/Hk	-12°	2°	0°	38-144D-0073	38-134D-0073	38-244D-0073	38-234D-0073	Offset Base/Hk Distal
L5/OB	-17°	2°	0°	38-1450-0073	38-1350-0073	38-2450-0073	38-2350-0073	Offset Base
L5/OB/Hk	-17°	2°	0°	38-145D-0073	38-135D-0073	38-245D-0073	38-235D-0073	Offset Base/Hk Distal

Single Patient Kits				Part Numbers		Notes
Rx	Upper Arch	Lower Arch	Hooks	018	022	
MBT	5-5	5-5	3	38-1CC3-0020	38-2CC3-0020	Hooks on 3's only
MBT	5-5	5-5	U3, L3,4	38-1C34-0020	38-2C34-0020	Hooks on U3, L3,4
MBT	5-5	5-5	3,4	38-1CC4-0020	38-2CC4-0020	Hooks on 3,4
MBT	5-5	5-5	3,4,5	38-1CC5-0020	38-2CC5-0020	Hooks on 3,4,5
MBT	5-5	---	3	---	38-2C03-0020	Upper only, hks on 3's
MBT	---	5-5	3,4	38-10C4-0020	38-20C4-0020	Lower only, Hks 3,4
MBT	---	5-5	3,4,5	38-10C5-0020	38-20C5-0020	Lower only, Hks 3,4,5



Color Codes



The distal-gingival color code allows an identification of the bracket to prevent bonding errors. For some prescriptions, these color codes may be different on the bicuspid.

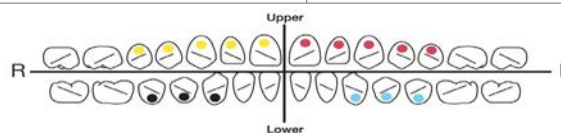

EXPERIENCE

The EXPERIENCE collection of self-ligating appliances each offer their own unique form of precision, aesthetics, and patient comfort without compromise to your orthodontic treatment plan. Wires are passive early in treatment, and actively engage as larger wire sizes are introduced towards finishing, offering optimal control throughout. Numerous prescriptions are available for treatment versatility.



EXPERIENCE Metal: This classic self-ligating twin provides both low friction and control which are the most sought after parameters in orthodontic appliances today.

EXPERIENCE Metal RHODIUM: Virtually invisible aesthetic version of the classic self-ligating metal bracket. Totally interchangeable with both EXPERIENCE Ceramic and EXPERIENCE Metal.



EXPERIENCE Ceramic: This ceramic self-ligating twin delivers outstanding aesthetics and performance. The clip is rhodium treated and blends into the ceramic body of the bracket. EXPERIENCE ceramic is compatible with EXPERIENCE metal.

EXPERIENCE Mini Ceramic: With the same treatment advantages, of EXPERIENCE Ceramic, the new EXPERIENCE Mini Ceramic is **20% smaller** than virtually every other SL ceramic bracket on the market!

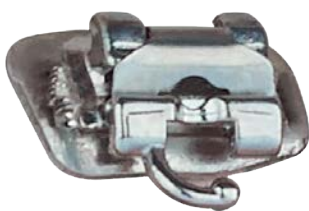

EXPERIENCE Molar Tubes: EXPERIENCE self-ligating buccal tubes are low profile, easy to open and close, and have both large and small base options. The perfect complement to the EXPERIENCE bracket line.

EXPERIENCE LSB: This smaller based lingual bracket is the tool of choice for lingual treatment of more crowded spaces, or when indications are for a more direct approach to the minor tooth movements associated with the social six.



EXPERIENCE Lingual: This low profile full lingual system offers exceptional patient comfort along with clinical effectiveness. Its gold colored clip provides easy citing for opening and closing procedures. Reliability and ease of use makes this the choice for lingual treatment.

*Roth/MBT/Andrews/Alexander/Bioprogressive prescriptions are not endorsed specifically by the named orthodontist(s).



EXPERIENCE metal

SL Product

The EXPERIENCE collection of self-ligating orthodontic brackets offer doctors and patients a variety of options for their orthodontic treatment needs. EXPERIENCE brackets minimize friction during initial leveling and aligning and allow for increased torque and rotation control during finishing.

Optional **laser-fused hooks** provide malleability & the ability to bend

Dual clip opening methods for easy clip opening without clip deformation

CNC milled slot

Torque in base ensures level slot alignment

Triple chamfered slot for easy wire engagement and to eliminate arch wire binding & notching

Smooth swept tie-wings engineered to minimize occlusal interference

Compound contoured pad ensures an anatomically correct fit for each tooth

Long axis scribe line for accurate positioning

80 gauge, micro-etched mesh for maximum bond strength

Palmer notation for easy tooth identification



Metal injection molding bracket for uniformity, strength & precision

Instruments

Instruments for specific use with the Experience line of brackets



This is a double ended tool designed to make both clip opening and wire insertion easy and efficient. Apply pressure with the circular end upon the gingival tail of the clip to open, while using the forked end to straddle the bracket and seat both sides of the wire simultaneously.

P/N. 50-1030-0000



This tool opens all Experience brackets from the gingival. The blunt scaler type end fits within the opening notch between the two gingival tie wings both safely and effectively.

P/N. 50-0030-0000

EXPERIENCE

EXPERIENCE Metal Roth



Maxillary				Part Numbers				Notes
Tooth	Torque	Angulation	Rotation	018R	018L	022R	022L	
U1	12°	5°	0°	20-1110-0010	20-1210-0010	20-2110-0010	20-2210-0010	
U2	8°	9°	0°	20-1120-0010	20-1220-0010	20-2120-0010	20-2220-0010	
U2/Hk	8°	9°	0°	20-112D-0010	20-122D-0010	20-212D-0010	20-222D-0010	Hk Distal
U3	-2°	13°	4°m	20-1130-0010	20-1230-0010	20-2130-0010	20-2230-0010	
U3/Hk	-2°	13°	4°m	20-113D-0010	20-123D-0010	20-213D-0010	20-223D-0010	Hk Distal
U3/Hk(Opt)	-2°	10°	4°m	20-113D-0012	20-123D-0012	20-213D-0012	20-223D-0012	Hk Distal
U4-5	-7°	0°	2°d	20-1140-0010	20-1240-0010	20-2140-0010	20-2240-0010	
U4-5/Hk	-7°	0°	2°d	20-114D-0010	20-124D-0010	20-214D-0010	20-224D-0010	Hk Distal
U4-5/Hk M	-7°	0°	2°d	20-114M-0010	20-124M-0010	20-214M-0010	20-224M-0010	Hk Mesial (Option)
U6	-10°	0°	14°d	20-1160-0010	20-1260-0010	20-2160-0010	20-2260-0010	Single Self-Ligating

Mandibular				Part Numbers				Notes
Tooth	Torque	Angulation	Rotation	018R	018L	022R	022L	
L1-2	-1°	2°	0°	20-1410-0010	20-1310-0010	20-2410-0010	20-2310-0010	Universal
L2/Hk	-1°	2°	0°	20-142D-0010	20-132D-0010	20-242D-0010	20-232D-0010	Hk Distal
L3	-11°	7°	2°m	20-1430-0010	20-1330-0010	20-2430-0010	20-2330-0010	
L3/Hk	-11°	7°	2°m	20-143D-0010	20-133D-0010	20-243D-0010	20-233D-0010	Hk Distal
L4	-17°	-1°	4°d	20-1440-0010	20-1340-0010	20-2440-0010	20-2340-0010	
L4/Hk	-17°	-1°	4°d	20-144D-0010	20-134D-0010	20-244D-0010	20-234D-0010	Hk Distal
L5	-22°	-1°	4°d	20-1450-0010	20-1350-0010	20-2450-0010	20-2350-0010	
L5/Hk	-22°	-1°	4°d	20-145D-0010	20-135D-0010	20-245D-0010	20-235D-0010	Hk Distal
L6	-25°	0°	4°d	20-1460-0010	20-1360-0010	20-2460-0010	20-2360-0010	Single Self-Ligating
L4/OB	-17°	-1°	4°d	20-1440-0013	20-1340-0013	20-2440-0013	20-2340-0013	Offset Base
L4/OB/Hk	-17°	-1°	4°d	—	20-134D-0013	20-244D-0013	20-234D-0013	Offset Base/Hk Distal
L5/OB	-22°	-1°	4°d	20-1450-0013	20-1350-0013	20-2450-0013	20-2350-0013	Offset Base
L5/OB/Hk	-22°	-1°	4°d	—	20-135D-0013	20-245D-0013	20-235D-0013	Offset Base/Hk Distal

Single Patient Kits				Part Numbers		Notes
Rx	Upper Arch	Lower Arch	Hooks	018	022	
Roth	5-5	5-5	3	20-1CC3-0010	20-2CC3-0010	Hooks on 3's only
Roth	5-5	5-5	3,4	20-1CC4-0010	20-2CC4-0010	Hooks on 3,4
Roth	5-5	5-5	3,4,5	20-1CC5-0010	20-2CC5-0010	All hooks distal 3,4,5
Roth	5-5	5-5	3,4,5	20-1CC5-0011	20-2CC5-0011	U4/5's Hks mesial
Roth	5-5	5-5	3,4,5	20-1CC5-0012	---	Hks 3,4,5 U3's Opt Ang

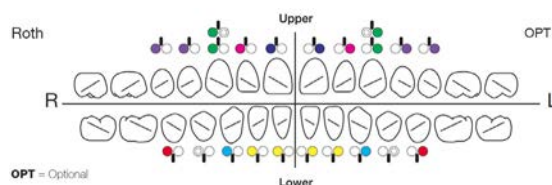



EXPERIENCE Metal MBT



Maxillary				Part Numbers				Notes
Tooth	Torque	Angulation	Rotation	018R	018L	022R	022L	
U1	17°	4°	0°	20-1110-0020	20-1210-0020	20-2110-0020	20-2210-0020	
U2	10°	8°	0°	20-1120-0020	20-1220-0020	20-2120-0020	20-2220-0020	
U3	-7°	8°	0°	—	—	20-2130-0020	20-2230-0020	
U3/Hk	-7°	8°	0°	20-113D-0020	20-123D-0020	20-213D-0020	20-223D-0020	Hk Distal
U3/Hk(Opt)	0°	8°	0°	20-113D-0021	20-123D-0021	20-213D-0021	20-223D-0021	Hk Distal
U4	-7°	0°	0°	20-1540-0020	20-1540-0020	20-2540-0020	20-2540-0020	Universal
U4-5/Hk	-7°	0°	0°	20-114D-0020	20-124D-0020	20-214D-0020	20-224D-0020	Hk Distal
U5	-7°	0°	0°	20-1550-0020	20-1550-0020	20-2550-0020	20-2550-0020	Universal
U4-5/Hk	-7°	0°	0°	20-115D-0020	20-125D-0020	20-215D-0020	20-225D-0020	Hk Distal
U6	-14°	0°	10°d	20-1160-0020	20-1260-0020	20-2160-0020	20-2260-0020	Single Self-Ligating
U6 (SB)	-14°	0°	10°d	20-1160-S020	20-1260-S020	20-2160-S020	20-2260-S020	Single SL/Small Base

Mandibular				Part Numbers				Notes
Tooth	Torque	Angulation	Rotation	018R	018L	022R	022L	
L1-2	-6°	0°	0°	20-1610-0020	20-1610-0020	20-2610-0020	20-2610-0020	Universal
L2/Hk	-6°	0°	0°	20-142D-0020	20-132D-0020	—	—	Hk Distal
L3	-6°	3°	0°	—	—	20-2430-0020	20-2330-0020	
L3/Hk	-6°	3°	0°	20-143D-0020	20-133D-0020	20-243D-0020	20-233D-0020	Hk Distal
L3/Hk(Opt)	0°	3°	0°	20-113D-0021	20-123D-0021	20-213D-0021	20-223D-0021	Hk Distal
L4	-12°	2°	0°	20-1440-0020	20-1340-0020	20-2440-0020	20-2340-0020	
L4/Hk	-12°	2°	0°	20-144D-0020	20-134D-0020	20-244D-0020	20-234D-0020	Hk Distal
L5	-17°	2°	0°	20-1450-0020	20-1350-0020	20-2450-0020	20-2350-0020	
L5/Hk	-17°	2°	0°	20-145D-0020	20-135D-0020	20-245D-0020	20-235D-0020	Hk Distal
L6	-20°	0°	0°	20-1460-0020	20-1360-0020	20-2460-0020	20-2360-0020	Single Self-Ligating
L6 (SB)	-20°	0°	0°	20-1460-S020	20-1360-S020	20-2460-S020	20-2360-S020	Single SL/Small Base

Single Patient Kits				Part Numbers		Notes
Rx	Upper Arch	Lower Arch	Hooks	018	022	
MBT	5-5	5-5	3	20-1CC3-0020	20-2CC3-0020	Hooks on 3's only
MBT	5-5	5-5	3,4	---	20-2CC4-0020	Hooks on 3,4
MBT	5-5	5-5	3,4,5	20-1CC5-0020	20-2CC5-0020	All hooks distal 3,4,5
MBT	5-5	5-5	U3, L3,4	20-1C34-0020	20-2C34-0020	Hooks on U3, L3,4

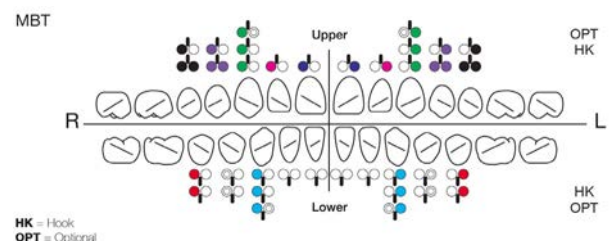

EXPERIENCE



EXPERIENCE Metal XT

Maxillary				Part Numbers				Notes
Tooth	Torque	Angulation	Rotation	018R	018L	022R	022L	
U1	18°	5°	0°	20-1110-0030	20-1210-0030	20-2110-0030	20-2210-0030	
U2	10°	8°	0°	20-1120-0030	20-1220-0030	20-2120-0030	20-2220-0030	
U2/Hk	10°	8°	0°	20-112D-0030	20-122D-0030	20-212D-0030	20-222D-0030	Hk Distal
U3	0°	8°	2°m	20-1130-0030	20-1230-0030	20-2130-0030	20-2230-0030	
U3/Hk	0°	8°	2°m	20-113D-0030	20-123D-0030	20-213D-0030	20-223D-0030	Hk Distal
U4-5	-10°	4°	2°d	20-1140-0030	20-1240-0030	20-2140-0030	20-2240-0030	
U4-5/Hk	-10°	4°	2°d	20-114M-0030	20-124M-0030	20-214M-0030	20-224M-0030	Hk Mesial
U6	-20°	0°	20°d	—	—	20-2160-0030	20-2260-0030	Single Self-Ligating

Mandibular				Part Numbers				Notes
Tooth	Torque	Angulation	Rotation	018R	018L	022R	022L	
L1-2	1°	0°	0°	20-1610-0030	20-1610-0030	20-2610-0030	20-2610-0030	Universal
L3	-3°	7°	2°m	20-1430-0030	20-1330-0030	20-2430-0030	20-2330-0030	
L3/Hk	-3°	7°	2°m	20-143D-0030	20-133D-0030	20-243D-0030	20-233D-0030	Hk Distal
L4	-7°	-1°	2°d	20-1440-0030	20-1340-0030	20-2440-0030	20-2340-0030	
L4/Hk	-7°	-1°	2°d	20-144D-0030	20-134D-0030	20-244D-0030	20-234D-0030	Hk Distal
L6	-14°	0°	4°d	—	—	20-2460-0032	20-2360-0032	Single Self-Ligating
L6	-10°	0°	4°d	—	—	20-2460-0030	20-2360-0030	Double Self-Ligating

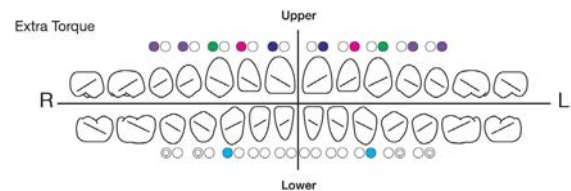

EXPERIENCE Metal Andrews

Maxillary				Part Numbers				Notes
Tooth	Torque	Angulation	Rotation	018R	018L	022R	022L	
U1	7°	5°	0°	—	—	20-2110-0044	20-2210-0044	
U2	3°	9°	0°	—	—	20-2120-0044	20-2220-0044	
U3/Hk	-7°	11°	0°	—	—	20-213D-0044	20-223D-0044	Hk Distal
U4-5	-7°	0°	0°	—	—	20-2540-0044	20-2540-0044	

Mandibular				Part Numbers				Notes
Tooth	Torque	Angulation	Rotation	018R	018L	022R	022L	
L1-2	-6°	2°	0°	—	—	20-2410-0044	20-2310-0044	
L1-2(Opt)	-1°	0°	0°	—	—	20-2610-0044	20-2610-0044	Universal
L3/Hk	-11°	5°	0°	—	—	20-243D-0044	20-233D-0044	Hk Distal
L4	-7°	0°	0°	—	—	20-2640-0044	20-2640-0044	Universal
L5	-7°	0°	0°	—	—	20-2650-0044	20-2650-0044	Universal





INSTRUMENTS



Experience C Opening Tool

Part # 50-1030-0000



This double ended tool is designed to make both clip opening and wire insertion easy and efficient. Apply pressure with the circular end upon the gingival tail of the clip to open, while using the forked end to straddle the bracket and seat both sides of the arch wire simultaneously.

Experience Opening Tool

Part # 50-0030-0000



This tool is designed specifically for the facial opening of the clip. The blunt scaler end fits within the opening notch between the two gingival tie wings both safely and effectively.

ADDITIONAL ITEMS



TYPODONTS



PATIENT BROCHURES



SINGLE PATIENT KITS

EXPERIENCE ceramic

EXPERIENCE ceramic

Hi Aesthetic **SL** Product

This ceramic self-ligating twin bracket delivers outstanding aesthetics and performance. The bracket features a rhodium treated clip that blends into the ceramic body of the bracket creating a beautiful appearance. The base is a 100% mechanical lock ensuring both reliable bond strength and easy debonding.

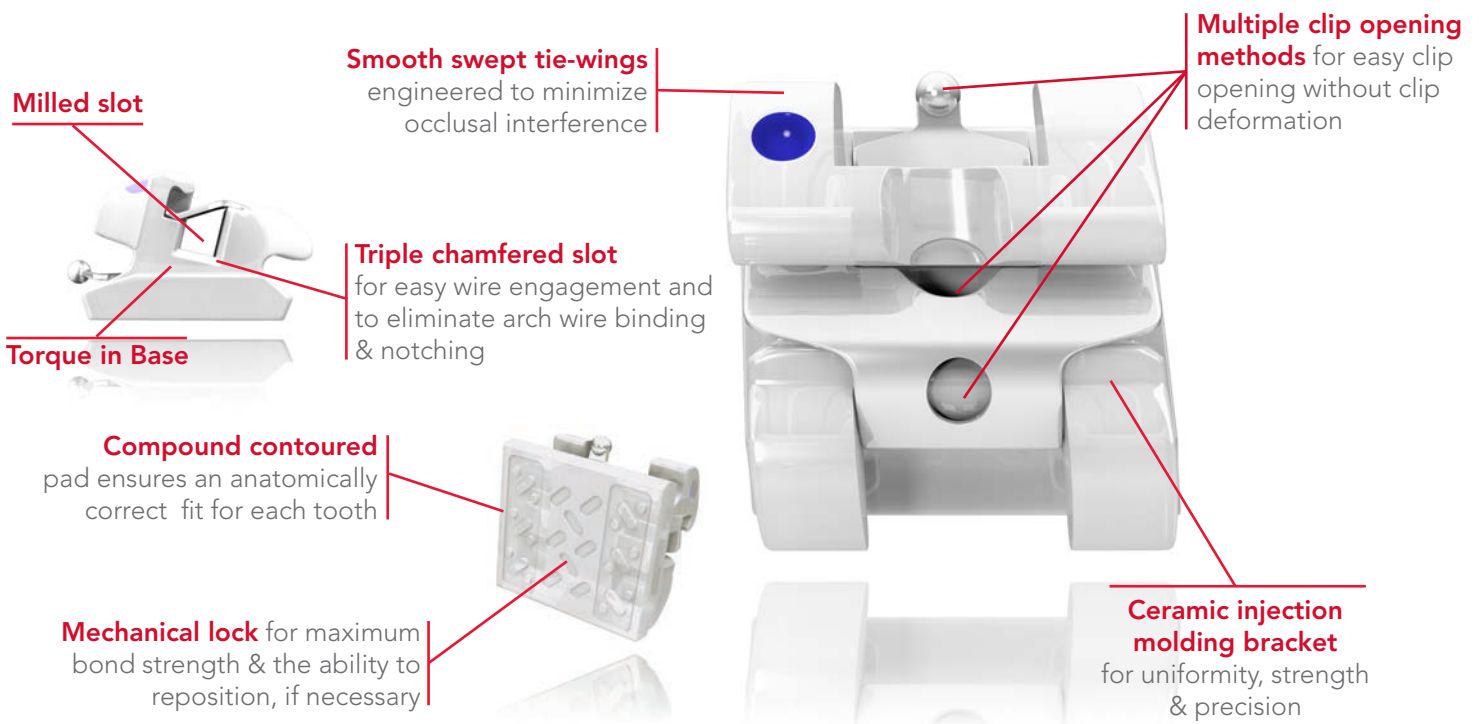

Color Codes

Disto-gingival color coding allows for quick bracket identification and bonding accuracy. Color Codes may differ for bicuspid for some prescriptions.

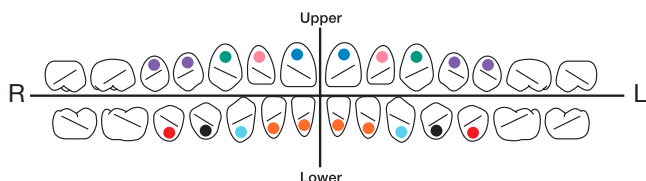

Rhodium Treated **Rh** Clip and Archwires

When combined with EXPERIENCE ceramic brackets, the overall aesthetics of the appliance are exceptional. See [page 97 and 101](#) of the Archwire section for rhodium wire options.





EXPERIENCE Ceramic Roth

Maxillary				Part Numbers				Notes
Tooth	Torque	Angulation	Rotation	018R	018L	022R	022L	
U1	12°	5°	0°	11-1110-0010	11-1210-0010	11-2110-0010	11-2210-0010	
U2	8°	9°	0°	11-1120-0010	11-1220-0010	11-2120-0010	11-2220-0010	
U3	-2°	13°	4°m	11-1130-0010	11-1230-0010	11-2130-0010	11-2230-0010	
U3/Hk	-2°	13°	4°m	11-113D-0010	11-123D-0010	11-213D-0010	11-223D-0010	Hk Distal
U4-5	-7°	0°	2°d	11-1140-0010	11-1240-0010	11-2140-0010	11-2240-0010	
U4-5/Hk	-7°	0°	2°d	11-114D-0010	11-124D-0010	11-214D-0010	11-224D-0010	Hk Distal

Mandibular				Part Numbers				Notes
Tooth	Torque	Angulation	Rotation	018R	018L	022R	022L	
L1-2	-1°	2°	0°	11-1410-0010	11-1310-0010	11-2410-0010	11-2310-0010	Universal
L3	-11°	7°	2°m	11-1430-0010	11-1330-0010	11-2430-0010	11-2330-0010	
L3/Hk	-11°	7°	2°m	11-143D-0010	11-133D-0010	11-243D-0010	11-233D-0010	Hk Distal
L4	-12°	2°	0°	11-1440-0020	11-1340-0020	11-2440-0020	11-2340-0020	
L4/Hk	-12°	2°	0°	11-144D-0020	11-134D-0020	11-244D-0020	11-234D-0020	Hk Distal
L5	-17°	2°	0°	11-1450-0020	11-1350-0020	11-2450-0020	11-2350-0020	
L5/Hk	-17°	2°	0°	11-145D-0020	11-135D-0020	11-245D-0020	11-235D-0020	Hk Distal



Single Patient Kits				Part Numbers		Notes
Rx	Upper Arch	Lower Arch	Hooks	018	022	
Roth	3-3	---	---	11-1E00-0010	11-2E00-0010	No hooks
Roth	3-3	---	3	11-1E03-0010	11-2E03-0010	Hooks on 3's only
Roth	3-3	3-3	---	11-1EE0-0010	11-2EE0-0010	No hooks
Roth	3-3	3-3	3	11-1EE3-0010	11-2EE3-0010	Hooks on 3's only
Roth	5-5	---	---	11-1C00-0010	11-2C00-0010	No hooks
Roth	5-5	---	3	11-1C03-0010	11-2C03-0010	Hooks on 3's only
Roth	5-5	---	3,4,5	11-1C05-0010	11-2C05-0010	Hooks on 3,4,5
Roth	5-5	3-3	---	11-1CE0-0010	11-2CE0-0010	No hooks
Roth	5-5	3-3	3	11-1CE3-0010	11-2CE3-0010	Hooks on 3's only
Roth	5-5	3-3	---	11-1CE5-0010	11-2CE5-0010	Hooks on 3,4,5
Roth	5-5	5-5	3	---	11-2CC3-0010	Hooks on 3's only
Roth	5-5	5-5	3,4,5	---	11-2CC5-0010	Hooks on 3,4,5

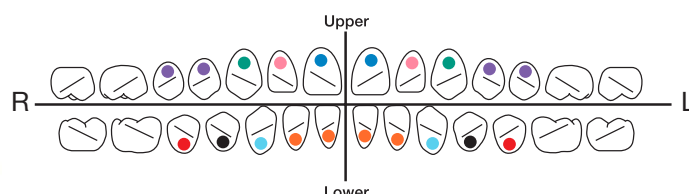

EXPERIENCE ceramic



EXPERIENCE Ceramic MBT

Maxillary				Part Numbers				Notes
Tooth	Torque	Angulation	Rotation	018R	018L	022R	022L	
U1	17°	4°	0°	11-1110-0020	11-1210-0020	11-2110-0020	11-2210-0020	
U2	10°	8°	0°	11-1120-0020	11-1220-0020	11-2120-0020	11-2220-0020	
U3/Hk	-7°	8°	0°	11-113D-0020	11-123D-0020	11-213D-0020	11-223D-0020	Hk Distal
U3/Hk(Opt)	0°	8°	0°	11-113D-0021	11-123D-0021	11-213D-0021	11-223D-0021	Hk Distal
U4-5	-7°	0°	0°	11-1540-0020	11-1540-0020	11-2540-0020	11-2540-0020	Universal
U4-5/Hk	-7°	0°	0°	11-114D-0020	11-124D-0020	11-214D-0020	11-224D-0020	Hk Distal
U5	-7°	0°	0°	11-1550-0020	11-1550-0020	11-2550-0020	11-2550-0020	Universal
U4-5/Hk	-7°	0°	0°	11-115D-0020	11-125D-0020	11-215D-0020	11-225D-0020	Hk Distal

Mandibular				Part Numbers				Notes
Tooth	Torque	Angulation	Rotation	018R	018L	022R	022L	
L1-2	-6°	0°	0°	11-1610-0020	11-1610-0020	11-2610-0020	11-2610-0020	Universal
L3/Hk	-6°	3°	0°	11-143D-0020	11-133D-0020	11-243D-0020	11-233D-0020	Hk Distal
L3/Hk(Opt)	0°	3°	0°	11-143D-0021	11-133D-0021	11-243D-0021	11-233D-0021	Hk Distal
L4	-12°	2°	0°	11-1440-0020	11-1340-0020	11-2440-0020	11-2340-0020	
L4/Hk	-12°	2°	0°	11-144D-0020	11-134D-0020	11-244D-0020	11-234D-0020	Hk Distal
L5	-17°	2°	0°	11-1450-0020	11-1350-0020	11-2450-0020	11-2350-0020	
L5/Hk	-17°	2°	0°	11-145D-0020	11-135D-0020	11-245D-0020	11-235D-0020	Hk Distal

Single Patient Kits				Part Numbers		Notes
Rx	Upper Arch	Lower Arch	Hooks	018	022	
MBT	3-3	---	3	11-1E03-0020	11-2E03-0020	Hooks on 3's only
MBT	3-3	3-3	3	11-1EE3-0020	11-2EE3-0020	Hooks on 3's only
MBT	5-5	3-3	3	11-1C03-0020	11-2C03-0020	Hooks on 3's only
MBT	5-5	—	3,4,5	11-1C05-0020	11-2C05-0020	Hooks on 3,4,5
MBT	5-5	3-3	3	11-1CE3-0020	11-2CE3-0020	Hooks on 3's only
MBT	5-5	3-3	3,4,5	11-1CE5-0020	11-2CE5-0020	Hooks on 3,4,5
MBT	5-5	5-5	3,4,5	11-1CC5-0020	11-2CC5-0020	Hooks on 3,4,5

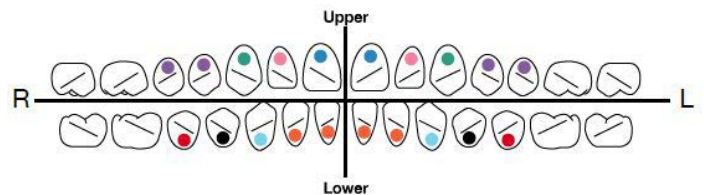

EXPERIENCE ceramic + EXPERIENCE metal Rhodium

Combine upper Experience Ceramic Brackets with lower Experience Metal Rhodium brackets for the ultimate in self-ligating aesthetics and functionality. See [page 29](#) for special kit options.





EXPERIENCE Ceramic XT

Maxillary				Part Numbers				Notes
Tooth	Torque	Angulation	Rotation	018R	018L	022R	022L	
U1	18°	4°	0°	11-1110-0030	11-1210-0030	11-2110-0030	11-2210-0030	
U2	10°	8°	0°	11-1120-0030	11-1220-0030	11-2120-0030	11-2220-0030	
U3/Hk	0°	8°	2°m	11-113D-0030	11-123D-0030	11-213D-0030	11-223D-0030	Hk Distal
U4-5	-10°	4°	2°d	11-1540-0030	11-1540-0030	11-2540-0030	11-2540-0030	Universal
U4-5/Hk	-10°	4°	2°d	11-114D-0030	11-124D-0030	11-214D-0030	11-224D-0030	Hk Distal

Mandibular				Part Numbers				Notes
Tooth	Torque	Angulation	Rotation	018R	018L	022R	022L	
L1-2	1°	0°	0°	11-1610-0030	11-1610-0030	11-2610-0030	11-2610-0030	Universal
L3/Hk	-3°	7°	2°m	11-143D-0030	11-133D-0030	11-243D-0030	11-233D-0030	Hk Distal

Single Patient Kits				Part Numbers		Notes
Rx	Upper Arch	Lower Arch	Hooks	018	022	
XT	3-3	---	3	11-1E03-0030	11-2E03-0030	Hooks on 3's only
XT	5-5	---	3	11-1C03-0030	11-2C03-0030	Hooks on 3's only

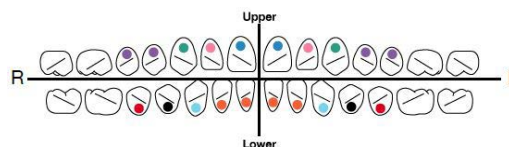

EXPERIENCE Ceramic Andrews

Maxillary				Part Numbers		Notes
Tooth	Torque	Angulation	Rotation	022R	022L	
U1	7°	5°	0°	11-2110-0044	11-2210-0044	
U2	3°	9°	0°	11-2120-0044	11-2220-0044	
U3/Hk	-7°	8°	0°	11-213D-0020	11-223D-0020	Hk Distal
U4-5	-7°	0°	0°	11-2540-0020	11-2540-0020	Universal

Mandibular				Part Numbers		Notes
Tooth	Torque	Angulation	Rotation	022R	022L	
L1-2	-6°	0°	0°	11-2610-0020	11-2610-0020	Universal
L3/Hk	-11°	7°	2°m	11-243D-0010	11-233D-0010	Hk Distal
L4	-17°	-1°	4°d	11-2440-0010	11-2340-0010	
L5	-22°	-1°	4°d	11-2450-0010	11-2350-0010	

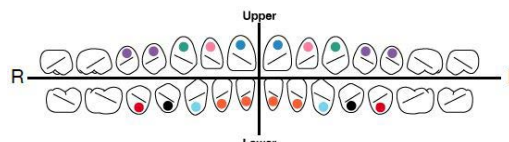

EXPERIENCE mini ceramic

NEW!

EXPERIENCE mini ceramic

Hi Aesthetic **SL** Product

This ceramic mini self-ligating twin bracket gives you the same performance advantages as Experience ceramic, but in a much smaller size for increased patient comfort and esthetics. The bracket features a rhodium treated clip that blends into the ceramic body of the bracket creating a beautiful appearance. The base is a 100% mechanical lock ensuring both reliable bond strength and easy debonding. The addition of palmer notation on the bonding base helps with bracket identification.

Milled slot

Torque in Base

Compound contoured pad ensures an anatomically correct fit for each tooth

Mechanical lock for maximum bond strength & the ability to reposition, if necessary

Palmer notation for easy tooth identification

Smooth swept tie-wings engineered to minimize occlusal interference

Triple chamfered slot for easy wire engagement and to eliminate arch wire binding & notching

Multiple clip opening methods for easy clip opening without clip deformation

20% smaller than virtually every other SL Ceramic Bracket available on the market!

Ceramic injection molded bracket for uniformity, strength & precision

Color Codes

Disto-gingival color coding allows for quick bracket identification and bonding accuracy. Color Codes may differ for bicuspid for some prescriptions.

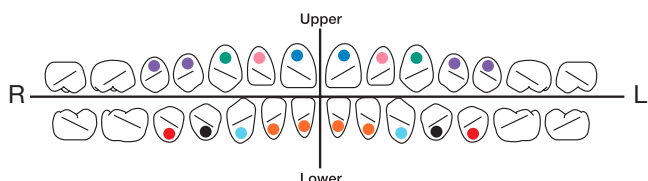

Rhodium Treated Clip and Archwires

When combined with EXPERIENCE ceramic brackets, the overall aesthetics of the appliance are exceptional. See [page 97 and 101](#) of the Archwire section for rhodium wire options.





EXPERIENCE Mini Ceramic MBT

Maxillary				Part Numbers				Notes
Tooth	Torque	Angulation	Rotation	018R	018L	022R	022L	
U1	17°	4°	0°	12-1110-0020	12-1210-0020	12-2110-0020	12-2210-0020	
U2	10°	8°	0°	12-1120-0020	12-1220-0020	12-2120-0020	12-2220-0020	
U3/Hk	-7°	8°	0°	12-113D-0020	12-123D-0020	12-213D-0020	12-223D-0020	Hk Distal
U3/Hk(Opt)	0°	8°	0°	12-113D-0021	12-123D-0021	12-213D-0021	12-223D-0021	Hk Distal
U4-5	-7°	0°	0°	12-1540-0020	12-1540-0020	12-2540-0020	12-2540-0020	Universal
U4-5/Hk	-7°	0°	0°	12-114D-0020	12-124D-0020	12-214D-0020	12-224D-0020	Hk Distal

Mandibular				Part Numbers				Notes
Tooth	Torque	Angulation	Rotation	018R	018L	022R	022L	
L1-2	-6°	0°	0°	12-1610-0020	12-1610-0020	12-2610-0020	12-2610-0020	Universal
L3/Hk	-6°	3°	0°	12-143D-0020	12-133D-0020	12-243D-0020	12-233D-0020	Hk Distal
L3/Hk(Opt)	0°	3°	0°	12-143D-0021	12-133D-0021	12-243D-0021	12-233D-0021	Hk Distal
L4	-12°	2°	0°	12-1440-0020	12-1340-0020	12-2440-0020	12-2340-0020	
L4/Hk	-12°	2°	0°	12-144D-0020	12-134D-0020	12-244D-0020	12-234D-0020	Hk Distal
L5	-17°	2°	0°	12-1450-0020	12-1350-0020	12-2450-0020	12-2350-0020	
L5/Hk	-17°	2°	0°	12-145D-0020	12-135D-0020	12-245D-0020	12-235D-0020	Hk Distal

Single Patient Kits				Part Numbers		Notes
Rx	Upper Arch	Lower Arch	Hooks	018	022	
MBT	3-3	---	3	12-1E03-0020	12-2E03-0020	Hooks on 3's only
MBT	3-3	3-3	3	12-1EE3-0020	12-2EE3-0020	Hooks on 3's only
MBT	5-5	---	3	12-1C03-0020	12-2C03-0020	Hooks on 3's only
MBT	5-5	3-3	3	12-1CE3-0020	12-2CE3-0020	Hooks on 3's only
MBT	5-5	—	3,4,5	12-1C05-0020	12-2C05-0020	Hooks on 3,4,5
MBT	5-5	3-3	3	12-1CE3-0020	12-2CE3-0020	Hooks on 3's only
MBT	5-5	3-3	3,4,5	12-1CE5-0020	12-2CE5-0020	Hooks on 3,4,5
MBT	5-5	5-5	3,4,5	12-1CC5-0020	12-2CC5-0020	Hooks on 3,4,5

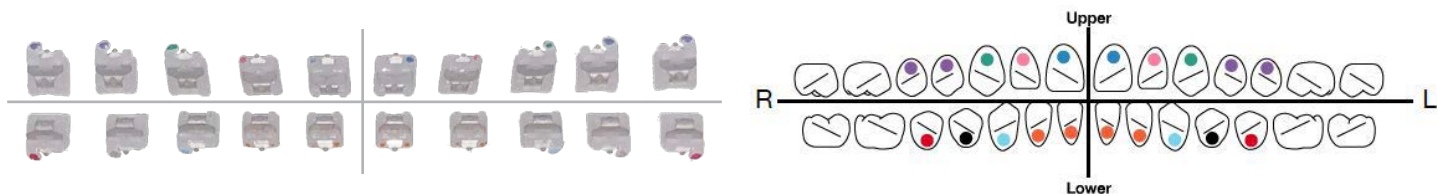

EXPERIENCE L

EXPERIENCE L

SL Product

EXPERIENCE L is one of the most sophisticated interactive lingual brackets available on the market. Its easy-to-access golden clip makes wire changes extremely accessible for practitioners, aiding to reduce treatment times and thus increasing patient satisfaction. Its small size limits speech interference and potential bonding failure.

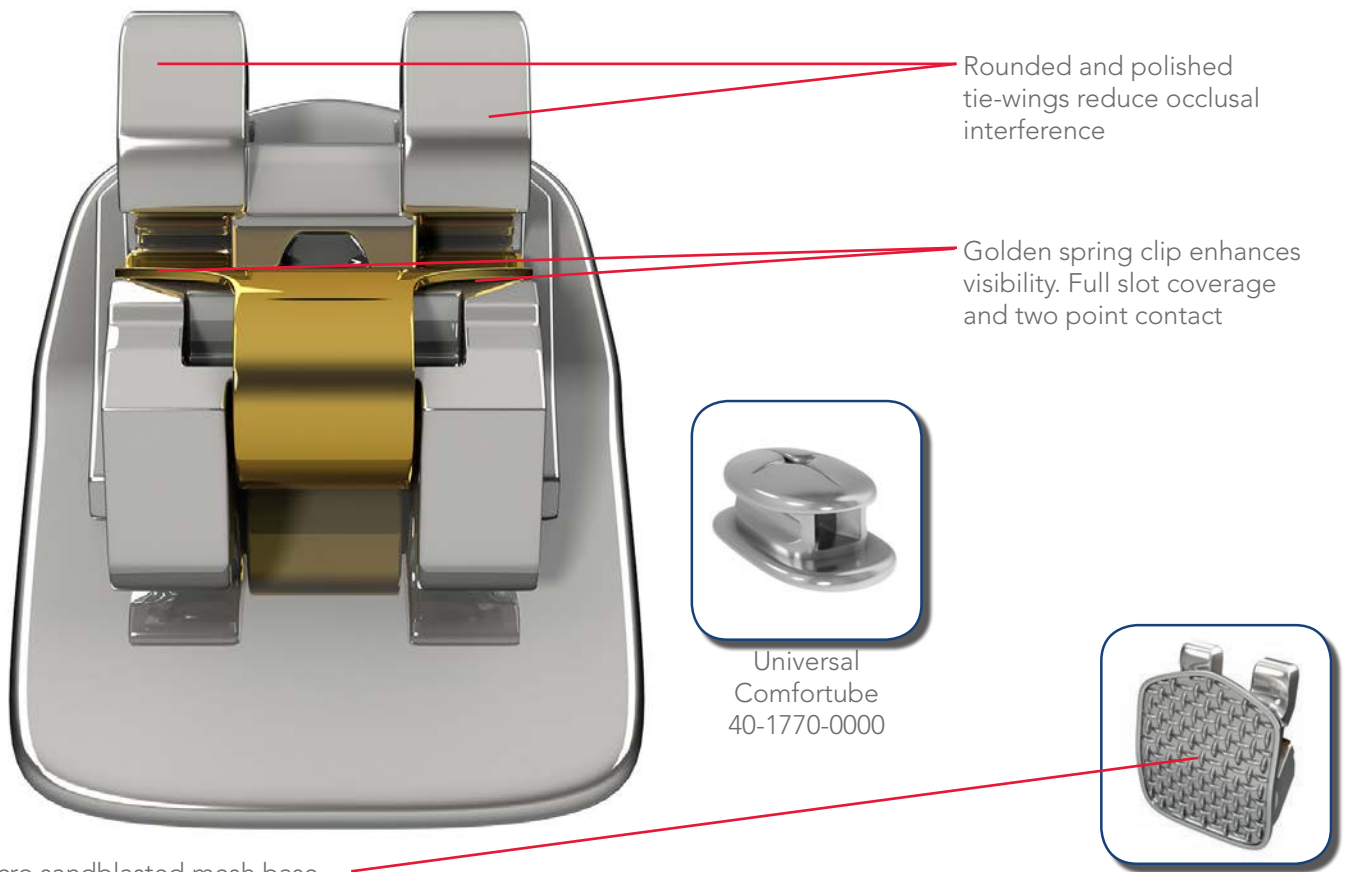

Micro sandblasted mesh base ensures superior retention

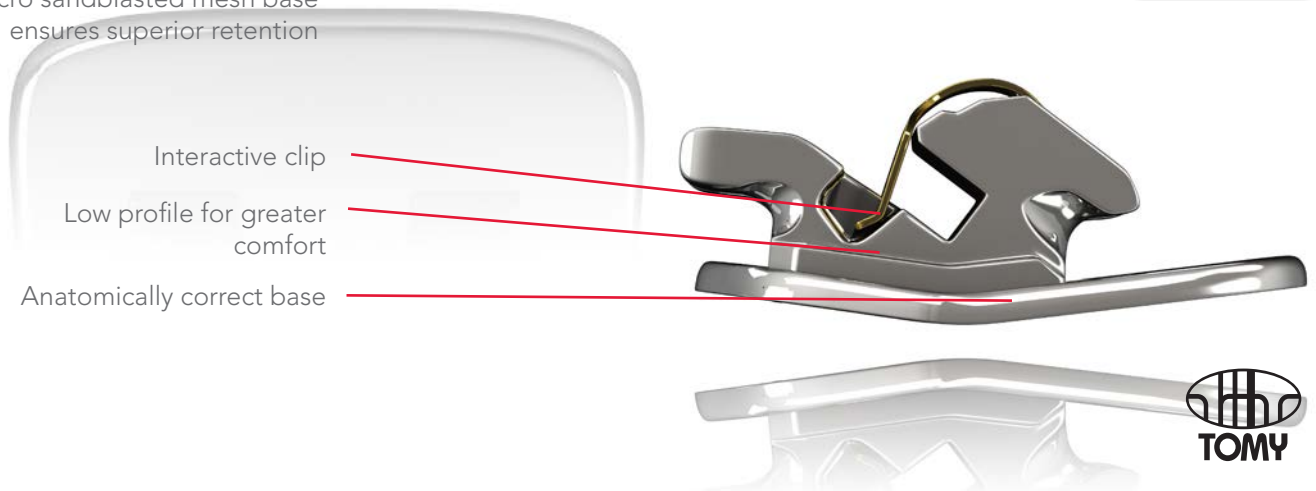



EXPERIENCE L



Maxillary

Tooth	Torque	Angulation	Rotation	Part Numbers		Notes
				018R	018L	
U1-2	60°	0°	0°	16-1510-0010	16-1510-0010	Universal
U3	60°	0°	0°	16-1530-0010	16-1530-0030	Universal
U3/Hk	60°	0°	0°	16-153U-0010	16-153U-0010	Hk Universal
U4-5	10°	0°	0°	16-1740-0010	16-1740-0010	Universal
U4-5/Hk	10°	0°	0°	16-174U-0010	16-174U-0010	Hk Universal
U6-7/Hk	10°	0°	0°	16-116M-0010	16-126M-0010	Molar Tube
U7/Comfortube	0°	0°	0°	40-1770-0000	40-1770-0000	Universal



Mandibular

Tooth	Torque	Angulation	Rotation	Part Numbers		Notes
				018R	018L	
L1-2	50°	0°	0°	16-1610-0010	16-1610-0010	Universal
L3	50°	0°	0°	16-1630-0010	16-1630-0010	Universal
L3/Hk	50°	0°	0°	16-163U-0010	16-163U-0010	Hk Universal
L4-5	10°	0°	0°	16-1740-0010	16-1740-0010	Universal
L4-5/Hk	10°	0°	0°	16-174U-0010	16-174U-0010	Hk Universal
L6-7/Hk	0°	0°	0°	16-146M-0010	16-136M-0010	Molar Tube
L7/Comfortube	0°	0°	0°	40-1770-0000	40-1770-0000	Universal

Single Patient Kits

Rx	Upper Arch	Lower Arch	Hooks	Part Numbers	Notes
				018	
Exp L	---	7-7	6,7	16-10A0-0010	Lower only, Hooks on 6,7
Exp L	7-7	---	6,7	16-1A00-0010	Upper only, Hooks on 6,7
Exp L	7-7	---	3,4,5,6,7	16-1A05-0010	Upper only, Hooks on 3,4,5,6,7
Exp L	7-7	7-7	6,7	16-1AA0-0010	Upper and Lower, Hooks on 6,7



HK = Hook

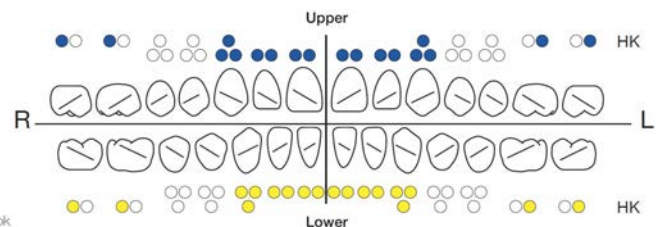

Experience Lingual Opening Tool

Part # 50-0678-7070

U Shaped Lingual Ligature Director with Picker



Comfortube Universal 7

EXPERIENCE LSB



EXPERIENCE LSB (Small Base)

EXPERIENCE LSB is a self-ligating lingual bracket similar to EXPERIENCE L, but with a smaller base. It is the tool of choice for aesthetic corrections for anterior alignment. Invisible, EXPERIENCE LSB is the perfect treatment option for discerning adult patients looking for an efficient cosmetic solution. Easy-to-bond through direct bonding on the lingual surface or indirectly via transfer trays.

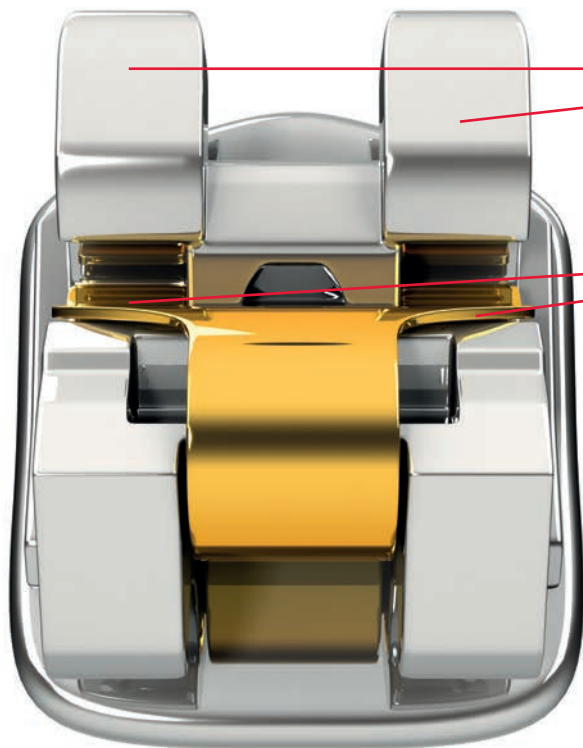

Rounded and polished tie-wings reduce occlusal interferences

Golden spring clip enhances visibility. Full slot coverage and two point contact



Lower incisor with narrow base
U: 17-153U-0010
L: 17-163U-0010



Micro sandblasted mesh base ensures superior retention

Interactive clip

Low profile for enhanced comfort

Anatomically correct base





EXPERIENCE LSB (SMALL BASE)



Maxillary

Tooth	Torque	Angulation	Rotation	Part Numbers		Notes
				018R	018L	
U1-2	60°	0°	0°	17-1510-0010	17-1510-0010	Universal
U3/Hk	60°	0°	0°	17-153U-0010	17-153U-0010	Hk Universal

Mandibular

Tooth	Torque	Angulation	Rotation	Part Numbers		Notes
				018R	018L	
L1-2-3	50°	0°	0°	17-1610-0010	17-1610-0010	Universal
L1-2-3/Narrow Base	50°	0°	0°	17-1610-0010	17-1610-0010	Universal
L3/Hk	50°	0°	0°	17-163U-0010	17-163U-0010	Hk Universal

Single Patient Kits

Rx	Upper Arch	Lower Arch	Hooks	Part Numbers	Notes
				018	
Exp LSB	3-3	—	—	17-1E00-0010	Upper 3-3 only, No Hook
Exp LSB	—	3-3	—	17-10E0-0010	Lower 3-3 only, No Hook
Exp LSB	3-3	3-3	—	17-1EE0-0010	Upper and Lower 3-3, No Hook
Exp LSB	4-4	4-4	—	17-1DD0-0010	Upper and Lower 4-4 only, No Hook
Exp LSB	7-7	7-7	6,7	17-1AA0-0010	Upper and Lower 7-7, Hooks on 6,7

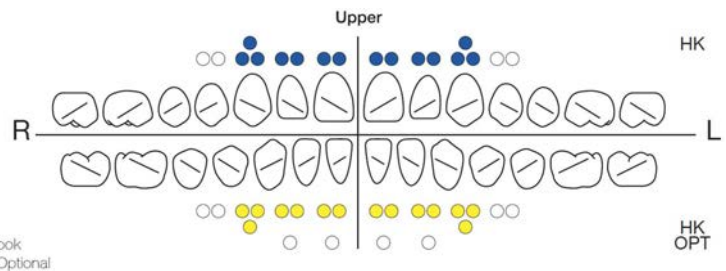

Lingual Archwires

GC Orthodontics Lingual Archwires provide you with several options for treating your "invisible braces" patients. There are a variety of archforms and sizes available.

GC Orthodontics Lingual Archwires can be found on [page 104](#) of the catalog.

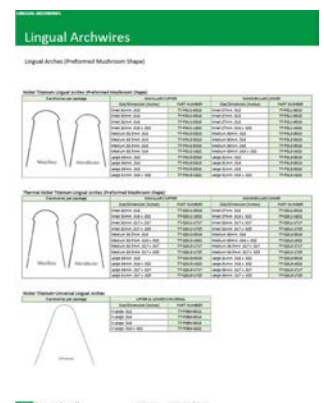

Chic

Chic.

 **Aesthetic**

Chic is the answer for doctors who want an impressive ceramic bracket option for their patients without compromising the performance or strength of the bracket. Chic is manufactured by Ceramic Injection Molding (CIM) creating uniformity, strength, and a true mechanical base. Its translucency compliments the patient's tooth shade while offering optimum stain resistance.



Color Codes 

Disto-gingival color coding allows for quick bracket identification and bonding accuracy.

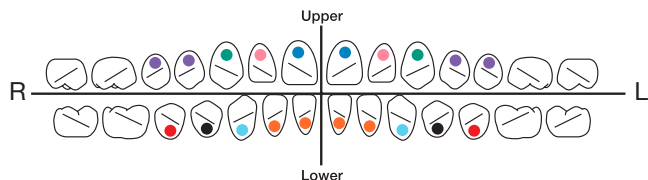



CHIC Ceramic Roth



Maxillary				Part Numbers				Notes
Tooth	Torque	Angulation	Rotation	018R	018L	022R	022L	
U1	12°	5°	0°	14-1110-0010	14-1210-0010	14-2110-0010	14-2210-0010	
U2	8°	9°	0°	14-1120-0010	14-1220-0010	14-2120-0010	14-2220-0010	
U3/Hk	-2°	13°	4°m	14-113D-0010	14-123D-0010	14-213D-0010	14-223D-0010	Hk Distal
U4-5	-7°	0°	0°	14-1540-0010	14-1540-0010	14-2540-0010	14-2540-0010	
U4-5/Hk M	-7°	0°	0°	14-114M-0010	14-124M-0010	14-214M-0010	14-224M-0010	Hk Mesial
U4-5/Hk U	-7°	0°	0°	14-154U-0010	14-154U-0010	14-254U-0010	14-254U-0010	Hk Universal

Mandibular				Part Numbers				Notes
Tooth	Torque	Angulation	Rotation	018R	018L	022R	022L	
L1-2	-1°	0°	0°	14-1610-0010	14-1610-0010	14-2610-0010	14-2610-0010	Universal
L3/Hk	-11°	7°	2°m	14-143D-0010	14-133D-0010	14-243D-0010	14-233D-0010	Hk Distal
L4	-17°	0°	0°	14-1640-0010	14-1640-0010	14-2640-0010	14-2640-0010	
L4/Hk	-17°	0°	0°	14-144D-0010	14-134D-0010	14-244D-0010	14-234D-0010	Hk Distal
L5	-22°	0°	0°	14-1650-0010	14-1650-0010	14-2650-0010	14-2650-0010	
L5/Hk	-22°	0°	0°	14-145D-0010	14-135D-0010	14-245D-0010	14-235D-0010	Hk Distal

Single Patient Kits				Part Numbers		Notes
Rx	Upper Arch	Lower Arch	Hooks	018	022	
Roth	3-3	—	3	—	14-2E03-0010	Hooks on 3's only
Roth	3-3	3-3	3	14-1EE3-0010	14-2EE3-0010	Hooks on 3's only
Roth	4-4	4-4	3,4	14-1DD4-S010	—	Hooks on 3,4 single hook*
Roth	4-4	4-4	3,4	14-1DD4-0010	—	Hooks on 3,4 U-hook*
Roth	5-5	—	3	14-1C03-0010	14-2C03-0010	Hooks on 3's only
Roth	5-5	—	3,4,5	14-1C05-S010	14-2C05-S010	Hooks on 3,4,5 single hook*
Roth	5-5	—	3,4,5	14-1C05-0010	14-2C05-0010	Hooks on 3,4,5 U-hook*
Roth	5-5	5-5	3	14-1CC3-0010	14-2CC3-0010	Hooks on 3's only
Roth	5-5	5-5	3,4	14-1CC4-S010	14-2CC4-S010	Hooks on 3,4 single hook*
Roth	5-5	5-5	3,4	14-1CC4-0010	14-2CC4-0010	Hooks on 3,4 U-hook*
Roth	5-5	5-5	3,4,5	14-1CC5-S010	14-2CC5-S010	Hooks on 3,4,5 single hook*
Roth	5-5	5-5	3,4,5	14-1CC5-0010	14-2CC5-0010	Hooks on 3,4,5 U-hook*
Roth	5-5	3-3	3	14-1CE3-0010	14-2CE3-0010	Hooks on 3's only
Roth	5-5	3-3	3,4,5	14-1CE5-S010	14-2CE5-S010	Hooks on 3,4,5 single hook*
Roth	5-5	3-3	3,4,5	14-1CE5-0010	14-2CE5-0010	Hooks on 3,4,5 U-hook*



*Chic upper bicuspid bracket hook options:



Single Hook



U-Hook



Chic

CHIC Ceramic MBT

Maxillary				Part Numbers				Notes
Tooth	Torque	Angulation	Rotation	018R	018L	022R	022L	
U1	17°	4°	0°	14-1110-0020	14-1210-0020	14-2110-0020	14-2210-0020	
U2	10°	8°	0°	14-1120-0020	14-1220-0020	14-2120-0020	14-2220-0020	
U3/Hk	-7°	8°	0°	14-113D-0020	14-123D-0020	14-213D-0020	14-223D-0020	Hk Distal
U3/Hk(Opt)	0°	8°	0°	14-113D-0021	14-123D-0021	14-213D-0021	14-223D-0021	Hk Distal
U4	-7°	0°	0°	14-1540-0020	14-1540-0020	14-2540-0020	14-2540-0020	Universal
U4-5/Hk D	-7°	0°	0°	14-114D-0020	14-124D-0020	14-214D-0020	14-224D-0020	Hk Distal
U4-5/Hk U	-7°	0°	0°	14-154U-0020	14-154U-0020	14-254U-0020	14-254U-0020	Hk Universal
U5	-7°	0°	0°	14-1550-0020	14-1550-0020	14-2550-0020	14-2550-0020	Universal

Mandibular				Part Numbers				Notes
Tooth	Torque	Angulation	Rotation	018R	018L	022R	022L	
L1-2	-6°	0°	0°	14-1610-0020	14-1610-0020	14-2610-0020	14-2610-0020	Universal
L3/Hk	-6°	3°	0°	14-143D-0020	14-133D-0020	14-243D-0020	14-233D-0020	Hk Distal
L3/Hk(Opt)	0°	3°	0°	14-143D-0021	14-133D-0021	14-243D-0021	14-233D-0021	Hk Distal
L4	-12°	0°	0°	14-1640-0020	14-1640-0020	14-2640-0020	14-2640-0020	Universal
L4/Hk	-12°	0°	0°	14-144D-0020	14-134D-0020	14-244D-0020	14-234D-0020	Hk Distal
L5	-17°	0°	0°	14-1650-0020	14-1650-0020	14-2650-0020	14-2650-0020	Universal
L5/Hk	-17°	0°	0°	14-145D-0020	14-135D-0020	14-245D-0020	14-235D-0020	Hk Distal



Single Patient Kits				Part Numbers		Notes
Rx	Upper Arch	Lower Arch	Hooks	018	022	
MBT	3-3	—	3	—	14-2E03-0020	Hooks on 3's only
MBT	5-5	—	3	—	14-2C03-0020	Hooks on 3's only
MBT	5-5	—	3,4,5	14-1C05-S020	14-2C05-S020	Hooks on 3,4,5 single hook*
MBT	5-5	—	3,4,5	14-1C05-0020	14-2C05-0020	Hooks on 3,4,5 U-hook*
MBT	5-5	5-5	3	—	14-2CE3-0020	Hooks on 3's only
MBT	5-5	5-5	3,4	14-1C34-S020	14-2C34-S020	Hooks on 3,4 single hook*
MBT	5-5	5-5	3,4	14-1C34-0020	14-2C34-0020	Hooks on 3,4 U-hook*
MBT	5-5	5-5	3,4,5	—	14-2CE5-0020	Hooks on 3,4,5
MBT	5-5	5-5	3	14-1CC3-0020	14-2CC3-0020	Hooks on 3's only
MBT	5-5	5-5	3,4	—	14-2CC4-S020	Hooks on 3,4 single hook*
MBT	5-5	5-5	3,4	—	14-2CC4-0020	Hooks on 3,4 U-hook*
MBT	5-5	5-5	3,4,5	14-1CC5-S020	14-2CC5-S020	Hooks on 3,4,5 single hook*
MBT	5-5	5-5	3,4,5	14-1CC5-0020	14-2CC5-0020	Hooks on 3,4,5 U-hook*

*Chic upper bicuspid bracket hook options:



Single Hook



U-Hook



Chic + LEGEND RHODIUM
 EXPERIENCE ceramic + EXPERIENCE



Not everyone prefers using ceramic brackets on lower teeth. Rhodium aesthetic metal twin and self-ligating brackets give you the ultimate combination of aesthetics and safety for your patients. Chic upper and Rhodium lower will please everyone. *Seeing is believing!*



Chic Ceramic Twin Upper/Legend Rhodium Twin Lower



Hj Aesthetic

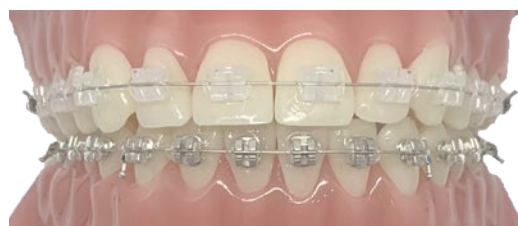

Single Patient Kits				Part Numbers		
Rx	Upper Arch	Lower Arch	Hooks	018	022	Notes
Roth	5-5 Ceramic	5-5 Rhodium	3	14/38-1CC3-0010	14/38-2CC3-0010	Hooks on 3's only
MBT	5-5 Ceramic	5-5 Rhodium	3	14/38-1CC3-0020	14/38-2CC3-0020	Hooks on 3's only
MBT	5-5 Ceramic	5-5 Rhodium	U3, L3,4	—	14/38-2C34-0020	Hooks on U3, L3,4
MBT	5-5 Ceramic	5-5 Rhodium	3,4,5	—	14/38-2CC5-S020	Hooks on 3,4,5 single hook*
MBT	5-5 Ceramic	5-5 Rhodium	3,4,5	—	14/38-2CC5-0020	Hooks on 3,4,5

*Chic upper bicuspid bracket hook options:



Single Hook



U-Hook

Experience Ceramic SL Upper/Experience Rhodium SL Lower

EXPERIENCE ceramic
 EXPERIENCE metal Rhodium



Hj Aesthetic **SL** Product



Single Patient Kits				Part Numbers		
Rx	Upper Arch	Lower Arch	Hooks	018	022	Notes
Roth	5-5 Ceramic	5-5 Rhodium	3,4,5	11/19-1CC5-0010	11/19-2CC5-0010	Hooks on 3,4,5
MBT	5-5 Ceramic	5-5 Rhodium	3,4,5	11/19-1CC5-0020	11/19-2CC5-0020	Hooks on 3,4,5

LEGEND

LEGEND Mini/LEGEND Medium

The LEGEND collection is a Low Profile traditional twin metal bracket system, available in a medium and mini size. LEGEND brackets are manufactured by a Metal Injection Molding (MIM) and Computer Numerical Controlled (CNC) precision milling process for a consistent and precise bracket that features a 100% accurate slot and anatomically correct bonding pads for maximum bond retention.

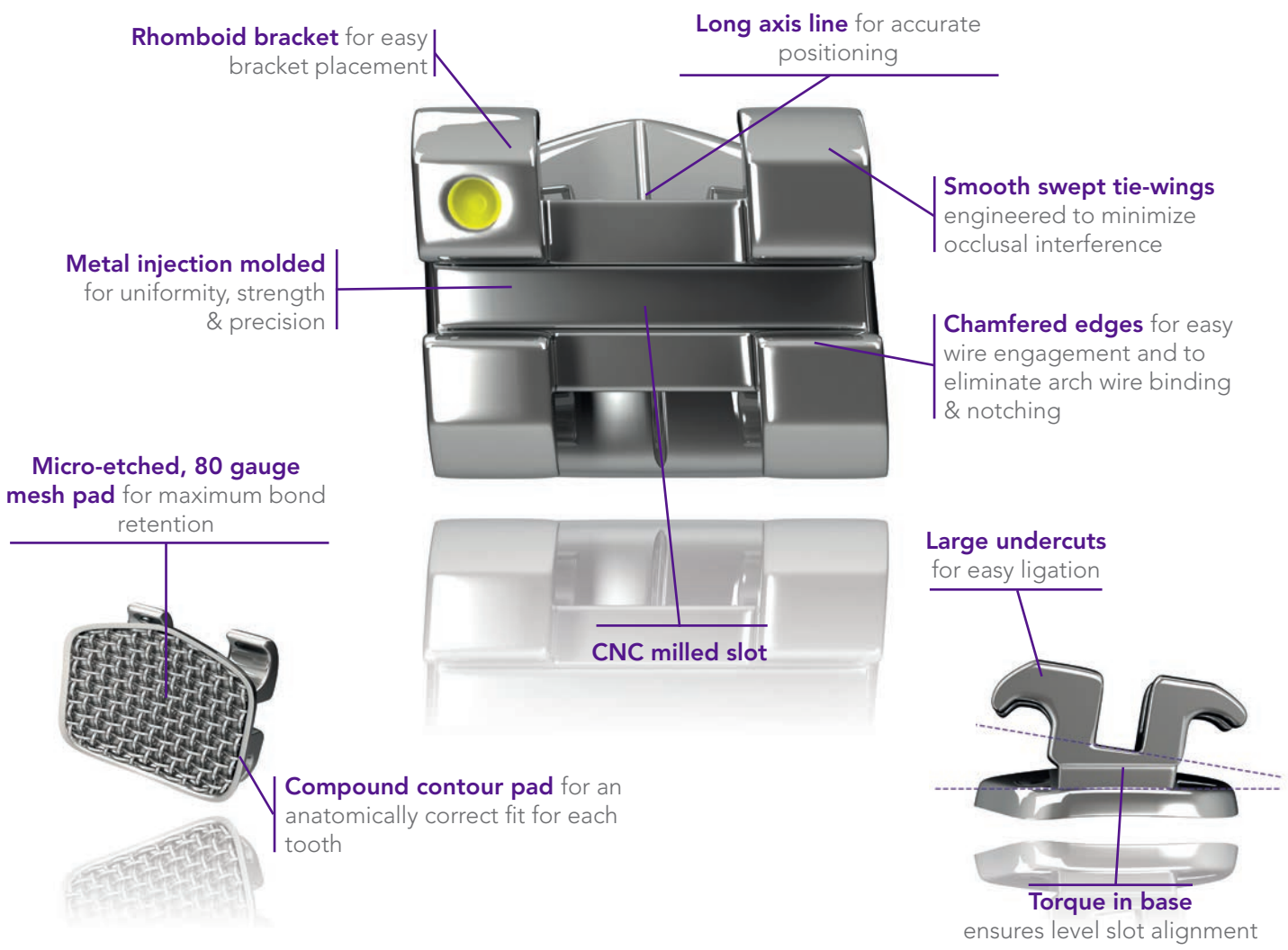

Color Codes

Disto-gingival color coding allows for quick bracket identification and bonding accuracy. For some prescriptions, these Color Codes may be different on the bicuspid.

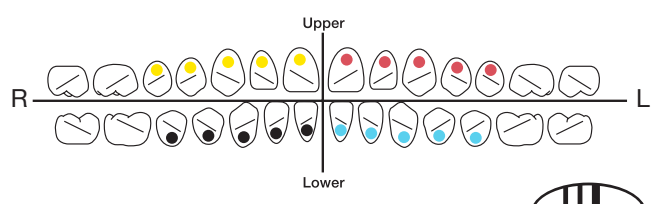



Bracket Identification



Legend Mini Bracket Identification

All Legend Mini brackets are notched and color coded on the distolingual tie wings as follows:

Upper Right - Yellow



Upper Left - Red



Lower Right - Black



Lower Left - Blue



Maxillary cuspids are color coded on both the distolingual and mesiolingual wings by quadrant. Scribe lines are used for further identifying Legend Mini brackets. The entire mandibular arch has a single scribe line running across the gingival wings. The mandibular second bicuspids have an additional scribe line on the incisal wings, and the maxillary second bicuspids have a scribe line running across the incisal wings. All angulated brackets are notched on the distolingual tie wing.

Patient Orientation

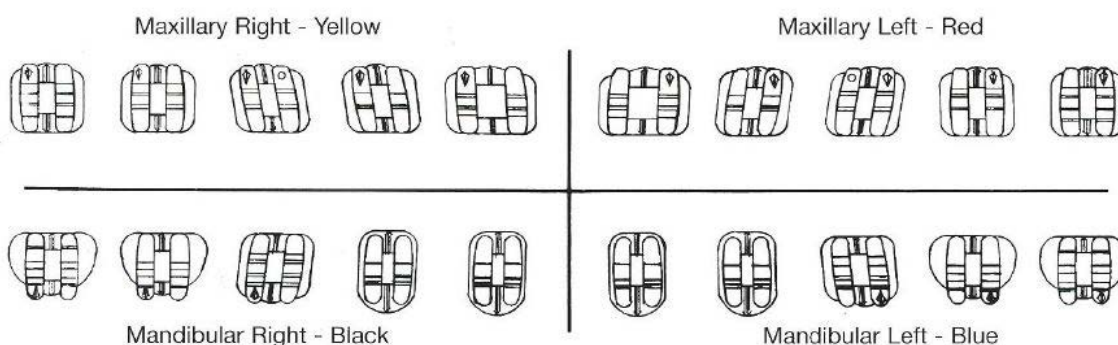

Color Codes

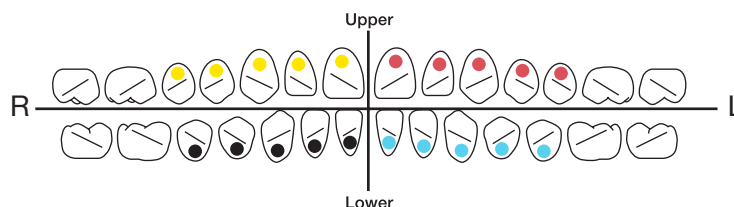

LEGEND Mini

LEGEND Mini Roth

CHART IDENTIFICATION

BALL HOOK

OPTION

OFFSET BASE

Maxillary				Part Numbers				Notes
Tooth	Torque	Angulation	Rotation	018R	018L	022R	022L	
U1	12°	5°	0°	31-1110-0010	31-1210-0010	31-2110-0010	31-2210-0010	
U2	8°	9°	0°	31-1120-0010	31-1220-0010	31-2120-0010	31-2220-0010	
U2/Hk	8°	9°	0°	31-112D-0010	31-122D-0010	31-212D-0010	31-222D-0010	Hk Distal
U3	-2°	10°	4°m	31-1130-0010	31-1230-0010	31-2130-0010	31-2230-0010	
U3/Hk	-2°	10°	4°m	31-113D-0010	31-123D-0010	31-213D-0010	31-223D-0010	Hk Distal
U4	-7°	0°	2°d	31-1140-0010	31-1240-0010	31-2140-0010	31-2240-0010	
U4/Hk	-7°	0°	2°d	31-114M-0010	31-124M-0010	31-214M-0010	31-224M-0010	Hk Mesial
U5	-7°	0°	2°d	31-1150-0010	31-1250-0010	31-2150-0010	31-2250-0010	
U5/Hk	-7°	0°	2°d	31-115M-0010	31-125M-0010	31-215M-0010	31-225M-0010	Hk Mesial
U4-5/OB	-7°	0°	0°	31-1540-0013	31-1540-0013	31-2540-0013	31-2540-0013	Offset Base/Universal
U4-5/OB/Hk	-7°	0°	0°	31-114M-0013	31-124M-0013	31-214M-0013	31-224M-0013	Offset Base/Hk Mesial

Mandibular				Part Numbers				Notes
Tooth	Torque	Angulation	Rotation	018R	018L	022R	022L	
L1-2	-1°	0°	0°	31-1610-0010	31-1610-0010	31-2610-0010	31-2610-0010	Universal
L2/Hk (D)	-1°	0°	0°	—	—	31-241D-0010	31-231D-0010	Hk Distal
L2/Hk (M)	-1°	0°	0°	—	—	31-242M-0010	31-232M-0010	Hk Mesial
L3	-11°	7°	2°m	31-1430-0010	31-1330-0010	31-2430-0010	31-2330-0010	
L3/Hk	-11°	7°	2°m	31-143D-0010	31-133D-0010	31-243D-0010	31-233D-0010	Hk Distal
L4	-17°	0°	4°d	31-1440-0010	31-1340-0010	31-2440-0010	31-2340-0010	
L4/Hk	-17°	0°	4°d	31-144D-0010	31-134D-0010	31-244D-0010	31-234D-0010	Hk Distal
L5	-22°	0°	4°d	31-1450-0010	31-1350-0010	31-2450-0010	31-2350-0010	
L5/Hk	-22°	0°	4°d	31-145D-0010	31-135D-0010	31-245D-0010	31-235D-0010	Hk Distal
L4/OB	-17°	0°	0°	31-1640-0013	31-1640-0013	31-2640-0013	31-2640-0013	Offset Base/Universal
L4/OB/Hk	-17°	0°	0°	31-144D-0013	31-134D-0013	31-244D-0013	31-234D-0013	Offset Base/Hk Distal
L5/OB	-22°	0°	0°	31-1650-0013	31-1650-0013	31-2650-0013	31-2650-0013	Offset Base/Universal
L5/OB/Hk	-22°	0°	0°	31-145D-0013	31-135D-0013	31-245D-0013	31-235D-0013	Offset Base/Hk Distal

Single Patient Kits				Part Numbers		Notes
Rx	Upper Arch	Lower Arch	Hooks	018	022	
Roth	5-5	5-5	—	—	31-2CC0-0010	No hooks
Roth	5-5	5-5	3	31-1CC3-0010	31-2CC3-0010	Hooks on 3's only
Roth	5-5	5-5	U3, L3,4	31-1C34-0010	—	Hooks on U3, L3,4
Roth	5-5	5-5	3,4	31-1CC4-0010	31-2CC4-0010	Hooks on 3,4
Roth	5-5	5-5	3,4,5	31-1CC5-0010	31-2CC5-0010	Hooks on 3,4,5



Color Codes



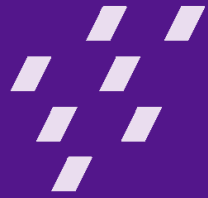

LEGEND Mini MBT

CHART IDENTIFICATION

BALL HOOK

OPTION

OFFSET BASE

Maxillary				Part Numbers				Notes
Tooth	Torque	Angulation	Rotation	018R	018L	022R	022L	
U1	17°	4°	0°	31-1110-0020	31-1210-0020	31-2110-0020	31-2210-0020	
U2	10°	8°	0°	31-1120-0020	31-1220-0020	31-2120-0020	31-2220-0020	
U3	-7°	8°	0°	31-1130-0020	31-1230-0020	31-2130-0020	31-2230-0020	
U3/Hk	-7°	8°	0°	31-113D-0020	31-123D-0020	31-213D-0020	31-223D-0020	Hk Distal
U3/Hk(Opt)	0°	8°	0°	31-113D-0021	31-123D-0021	31-213D-0021	31-223D-0021	Hk Distal
U4	-7°	0°	0°	31-1540-0020	31-1540-0020	31-2540-0020	31-2540-0020	Universal
U4/Hk	-7°	0°	0°	31-114D-0020	31-124D-0020	31-214D-0020	31-224D-0020	Hk Distal
U5	-7°	0°	0°	31-1550-0020	31-1550-0020	31-2550-0020	31-2550-0020	Universal
U5/Hk	-7°	0°	0°	31-115D-0020	31-125D-0020	31-215D-0020	31-225D-0020	Hk Distal
U4-5/OB	-7°	0°	0°	31-1540-0013	31-1540-0013	31-2540-0013	31-2540-0013	Offset Base/Universal
U4-5/OB/Hk	-7°	0°	0°	—	—	31-214D-0073	31-224D-0073	Offset Base/Hk Distal

Mandibular				Part Numbers				Notes
Tooth	Torque	Angulation	Rotation	018R	018L	022R	022L	
L1-2	-6°	0°	0°	31-1610-0020	31-1610-0020	31-2610-0020	31-2610-0020	Universal
L3/Hk	-6°	3°	0°	31-143D-0020	31-133D-0020	31-243D-0020	31-233D-0020	Hk Distal
L3/Hk(Opt)	0°	3°	0°	31-143D-0021	31-133D-0021	31-243D-0021	31-233D-0021	Hk Distal
L4	-12°	2°	0°	31-1440-0020	31-1340-0020	31-2440-0020	31-2340-0020	
L4/Hk	-12°	2°	0°	31-144D-0020	31-134D-0020	31-244D-0020	31-234D-0020	Hk Distal
L5	-17°	2°	0°	31-1450-0020	31-1350-0020	31-2450-0020	31-2350-0020	
L5/Hk	-17°	2°	0°	31-145D-0020	31-135D-0020	31-245D-0020	31-235D-0020	Hk Distal
L4/OB	-12°	2°	0°	31-1440-0073	31-1340-0073	31-2440-0073	31-2340-0073	Offset Base
L4/OB/Hk	-12°	2°	0°	31-144D-0073	31-134D-0073	31-244D-0073	31-234D-0073	Offset Base/Hk Distal
L5/OB	-17°	2°	0°	31-1450-0073	31-1350-0073	31-2450-0073	31-2350-0073	Offset Base
L5/OB/Hk	-17°	2°	0°	31-145D-0073	31-135D-0073	31-245D-0073	31-235D-0073	Offset Base/Hk Distal

Single Patient Kits				Part Numbers		Notes
Rx	Upper Arch	Lower Arch	Hooks	018	022	
MBT	5-5	5-5	3	31-1CC3-0020	31-2CC3-0020	Hooks on 3's only
MBT(Opt)	5-5	5-5	3	—	31-2CC3-0021	(0° T Cuspids) Hooks on 3's
MBT	5-5	5-5	U3, L3,4	—	31-2C34-0020	Hooks on U3, L3,4
MBT	5-5	5-5	3,4	31-1CC4-0020	31-2CC4-0020	Hooks on 3,4
MBT	5-5	5-5	3,4,5	31-1CC5-0020	31-2CC5-0020	Hooks on 3,4,5
MBT	—	5-5	3,4,5	—	31-20C5-0020	Hooks on 3,4,5

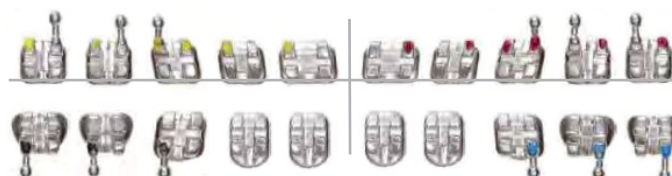

Color Codes

UR UL

LR LL

LEGEND Mini

LEGEND Mini Andrews

CHART IDENTIFICATION
BALL HOOK
OPTION
OFFSET BASE

Maxillary				Part Numbers				Notes
Tooth	Torque	Angulation	Rotation	018R	018L	022R	022L	
U1	7°	5°	0°	31-1110-0015	31-1210-0015	31-2110-0015	31-2210-0015	
U2	3°	9°	0°	31-1120-0015	31-1220-0015	31-2120-0015	31-2220-0015	
U3/Hk	-7°	10°	0°	---	---	31-213D-0015	31-223D-0015	Hk Distal
U3/Hk	-7°	8	0°	31-113D-0020	31-123D-0020	31-213D-0020	31-223D-0020	Hk Distal
U4-5	-7°	0°	0°	31-1540-0015	31-1540-0015	31-2540-0015	31-2540-0015	Universal
U4/Hk	-7°	0°	2°d	31-114M-0010	31-124M-0010	31-214M-0010	31-224M-0010	Hk Mesial
U4-5/OB	-7°	0°	0°	31-1540-0013	31-1540-0013	31-2540-0013	31-2540-0013	Offset Base/Universal
U4-5/OB/Hk	-7°	0°	0°	31-114M-0013	31-124M-0013	31-214M-0013	31-224M-0013	Offset Base/Hk Mesial

Mandibular				Part Numbers				Notes
Tooth	Torque	Angulation	Rotation	018R	018L	022R	022L	
L1-2	-6°	0°	0°	31-1610-0020	31-1610-0020	31-2610-0020	31-2610-0020	Universal
L2(Opt)	-1°	2°	0°	31-1410-0045	31-1310-0045	---	---	
L3/Hk	-11°	7°	2°m	31-143D-0010	31-133D-0010	31-243D-0010	31-233D-0010	Hk Distal
L4	-17°	0°	0°	31-1640-0015	31-1640-0015	31-2640-0015	31-2640-0015	Universal
L4/Hk	-17°	-1°	4°d	31-144D-0010	31-134D-0010	31-244D-0010	31-234D-0010	Hk Distal
L5	-22°	0°	0°	31-1650-0015	31-1645-0015	31-2650-0015	31-2650-0015	Universal
L5/Hk	-22°	-1°	4°d	31-145D-0010	31-135D-0010	31-245D-0010	31-235D-0010	Hk Distal
L4/OB	-17°	0°	0°	31-1640-0013	31-1640-0013	31-2640-0013	31-2640-0013	Offset Base/Universal
L4/OB/Hk	-17°	0°	0°	31-144D-0013	31-134D-0013	31-244D-0013	31-234D-0013	Offset Base/Hk Distal
L5/OB	-22°	0°	0°	31-1650-0013	31-1650-0013	31-2650-0013	31-2650-0013	Offset Base/Universal
L5/OB/Hk	-22°	0°	0°	31-145D-0013	31-135D-0013	31-245D-0013	31-235D-0013	Offset Base/Hk Distal

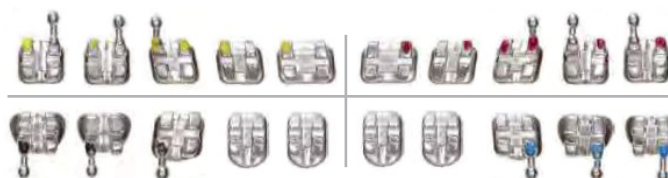

Color Codes





LEGEND Mini Bioprogressive

CHART
IDENTIFICATION
BALL HOOK

Maxillary				Part Numbers				Notes
Tooth	Torque	Angulation	Rotation	018R	018L	022R	022L	
U1	22°	5°	0°	31-1110-0027	31-1210-0027	31-2110-0027	31-2210-0027	
U2	13°	9°	0°	31-1120-0011	31-1220-0011	31-2120-0011	31-2220-0011	
U3/Hk	7°	5°	0°	31-113D-0027	31-123D-0027	—	—	Hk Distal
U4-5	0°	0°	0°	31-1540-0025	31-1540-0025	31-2540-0025	31-2540-0025	Universal

Mandibular				Part Numbers				Notes
Tooth	Torque	Angulation	Rotation	018R	018L	022R	022L	
L1-2	-1°	0°	0°	31-1610-0010	31-1610-0010	31-2610-0010	31-2610-0010	Universal
L3/Hk	7°	5°	0°	31-143D-0027	31-133D-0027	—	—	Hk Distal
L4-5	0°	0°	0°	31-1640-0025	31-1640-0025	31-2640-0025	31-2640-0025	Universal

LEGEND Mini XT

Maxillary				Part Numbers				Notes
Tooth	Torque	Angulation	Rotation	018R	018L	022R	022L	
U1	17°	5°	0°	31-1110-0011	31-1210-0011	31-2110-0011	31-2210-0011	
U2	10°	8°	0°	31-1120-0020	31-1220-0020	31-2120-0020	31-2220-0020	
U3/Hk	0°	7°	4°m	31-113D-0011	31-123D-0011	31-213D-0011	31-223D-0011	Hk Distal

Mandibular				Part Numbers				Notes
Tooth	Torque	Angulation	Rotation	018R	018L	022R	022L	
L1-2	-5°	0°	0°	31-1610-0011	31-1610-0011	31-2610-0011	31-2610-0011	Universal



Color Codes



LEGEND Mini

LEGEND Mini Complete Bracket Options - Upper

Maxillary				Part Numbers				Notes
Tooth	Torque	Angulation	Rotation	018R	018L	022R	022L	
U1	7°	5°	0°	31-1110-0015	31-1210-0015	31-2110-0015	31-2210-0015	AND
U1	12°	5°	0°	31-1110-0010	31-1210-0010	31-2110-0010	31-2210-0010	ROTH
U1	14°	5°	0°	31-1110-0031	31-1210-0031	31-2110-0031	31-2210-0031	ALEX
U1	17°	4°	0°	31-1110-0020	31-1210-0020	31-2110-0020	31-2210-0020	MBT
U1	17°	5°	0°	31-1110-0011	31-1210-0011	31-2110-0011	31-2210-0011	XT
U1	22°	5°	0°	31-1110-0027	31-1210-0027	31-2110-0027	31-2210-0027	BIO/HT
U2	3°	9°	0°	31-1120-0015	31-1220-0015	31-2120-0015	31-2220-0015	AND
U2	8°	9°	0°	31-1120-0010	31-1220-0010	31-2120-0010	31-2220-0010	ALEX
U2	8°	9°	0°	31-1120-0010	31-1220-0010	31-2120-0010	31-2220-0010	ROTH
U2/Hk	8°	9°	0°	31-112D-0010	31-122D-0010	31-212D-0010	31-222D-0010	ROTH/Hk Distal
U2	10°	8°	0°	31-1120-0020	31-1220-0020	31-2120-0020	31-2220-0020	MBT
U2	13°	9°	0°	31-1120-0011	31-1220-0011	31-2120-0011	31-2220-0011	BIO/XT
U3/Hk	7°	5°	0°	31-113D-0027	31-123D-0027	—	—	BIO/Hk Distal
U3/Hk	0°	7°	4°m	31-113D-0011	31-123D-0011	31-213D-0011	31-223D-0011	XT/Hk Distal
U3/Hk(Opt)	0°	8°	0°	31-113D-0021	31-123D-0021	31-213D-0021	31-223D-0021	MBT Opt/Hk Distal
U3	-2°	10°	4°m	31-1130-0010	31-1230-0010	31-2130-0010	31-2230-0010	ROTH
U3/Hk	-2°	10°	4°m	31-113D-0010	31-123D-0010	31-213D-0010	31-223D-0010	ROTH/Hk Distal
U3	-7°	8°	0°	31-1130-0020	31-1230-0020	31-2130-0020	31-2230-0020	MBT
U3/Hk	-7°	8°	0°	31-113D-0020	31-123D-0020	31-213D-0020	31-223D-0020	MBT/Hk Distal
U3/Hk	-7°	10°	0°	—	—	31-213D-0015	31-223D-0015	AND/Hk Distal
U4-5	0°	0°	0°	31-1540-0025	31-1540-0025	31-2540-0025	31-2540-0025	BIO/EDGEWISE
U4	-7°	0°	0°	31-1540-0020	31-1540-0020	31-2540-0020	31-2540-0020	MBT/Universal
U4/Hk	-7°	0°	0°	31-114D-0020	31-124D-0020	31-214D-0020	31-224D-0020	MBT/Hk Distal
U4-5	-7°	0°	0°	31-1540-0015	31-1540-0015	31-2540-0015	31-2540-0015	AND/Universal
U4	-7°	0°	2°d	31-1140-0010	31-1240-0010	31-2140-0010	31-2240-0010	ROTH
U4/Hk	-7°	0°	2°d	31-114M-0010	31-124M-0010	31-214M-0010	31-224M-0010	ROTH/Hk Mesial
U5	-7°	0°	0°	31-1550-0020	31-1550-0020	31-2550-0020	31-2550-0020	MBT/Universal
U5/Hk	-7°	0°	0°	31-115D-0020	31-125D-0020	31-215D-0020	31-225D-0020	MBT/Hk Distal
U4-5/OB	-7°	0°	0°	31-1540-0013	31-1540-0013	31-2540-0013	31-2540-0013	ROTH/Offset Base
U4-5/OB/Hk	-7°	0°	0°	31-114M-0013	31-124M-0013	31-214M-0013	31-224M-0013	ROTH/Offset Base/Hk
U4-5/OB/Hk	-7°	0°	0°	—	—	31-214D-0073	31-224D-0073	Offset Base/Hk Distal
U5	-7°	0°	2°d	31-1150-0010	31-1250-0010	31-2150-0010	31-2250-0010	ROTH
U5/Hk	-7°	0°	2°d	31-115M-0010	31-125M-0010	31-215M-0010	31-225M-0010	ROTH/Hk Mesial



LEGEND Mini Complete Bracket Options - Lower

Mandibular				Part Numbers				Notes
Tooth	Torque	Angulation	Rotation	018R	018L	022R	022L	
L1-2	0°	0°	0°	31-1610-0025	31-1610-0025	31-2610-0025	31-2610-0025	EDGEWISE/Universal
L1-2	-1°	0°	0°	31-1610-0010	31-1610-0010	31-2610-0010	31-2610-0010	ROTH/Universal
L2/Hk (D)	-1°	0°	0°	—	—	31-241D-0010	31-231D-0010	ROTH/Hk Distal
L2/Hk (M)	-1°	0°	0°	—	—	31-242M-0010	31-232M-0010	ROTH/Hk Mesial
L2 (Opt)	-1°	2°	0°	31-1410-0045	31-1310-0045	—	—	AND/Option
L1-2	-5°	0°	0°	31-1610-0011	31-1610-0011	31-2610-0011	31-2610-0011	XT/Universal
L1-2	-6°	0°	0°	31-1610-0020	31-1610-0020	31-2610-0020	31-2610-0020	MBT/Universal
L1-2	-10°	0°	0°	31-1610-0037	31-1610-0037	31-2610-0037	31-2610-0037	FUN/Universal
L3/Hk	7°	5°	0°	31-143D-0027	31-133D-0027	—	—	BIO/Hk Distal
L3/Hk(Opt)	0°	3°	0°	31-143D-0021	31-133D-0021	31-243D-0021	31-233D-0021	MBT/Hk Distal
L3/Hk	-6°	3°	0°	31-143D-0020	31-133D-0020	31-243D-0020	31-233D-0020	MBT/Hk Distal
L3	-11°	7°	2°m	31-1430-0010	31-1330-0010	31-2430-0010	31-2330-0010	ROTH
L3/Hk	-11°	7°	2°m	31-143D-0010	31-133D-0010	31-243D-0010	31-233D-0010	ROTH/Hk Distal
L4-5	0°	0°	0°	31-1640-0025	31-1640-0025	31-2640-0025	31-2640-0025	EDGE/BIO/Universal
L4	-11°	0°	0°	31-1640-0039	31-1640-0039	31-2640-0039	31-2640-0039	WSP/Universal
L4/Hk	-11°	0°	0°	—	—	31-244D-0039	31-234D-0039	WSP/Hk Distal
L4	-12°	2°	0°	31-1440-0020	31-1340-0020	31-2440-0020	31-2340-0020	MBT
L4/Hk	-12°	2°	0°	31-144D-0020	31-134D-0020	31-244D-0020	31-234D-0020	MBT/Hk Distal
L4/OB	-12°	2°	0°	31-1440-0073	31-1340-0073	31-2440-0073	31-2340-0073	MBT/Offset Base
L4/OB/Hk	-12°	2°	0°	31-144D-0073	31-134D-0073	31-244D-0073	31-234D-0073	MBT/Offset Base/HK D
L4	-17°	0°	0°	31-1640-0015	31-1640-0015	31-2640-0015	31-2640-0015	AND/Universal
L4/OB	-17°	0°	0°	31-1640-0013	31-1640-0013	31-2640-0013	31-2640-0013	Offset Base/Universal
L4/OB/Hk	-17°	0°	0°	31-144D-0013	31-134D-0013	31-244D-0013	31-234D-0013	Offset Base/Hk Distal
L4	-17°	-1°	4°d	31-1440-0010	31-1340-0010	31-2440-0010	31-2340-0010	ROTH
L4/Hk	-17°	-1°	4°d	31-144D-0010	31-134D-0010	31-244D-0010	31-234D-0010	ROTH/Hk Distal
L5	-17°	0°	0°	31-1650-0039	31-1650-0039	31-2650-0039	31-2650-0039	WSP/Universal
L5	-17°	2°	0°	31-1450-0020	31-1350-0020	31-2450-0020	31-2350-0020	MBT
L5/Hk	-17°	2°	0°	31-145D-0020	31-135D-0020	31-245D-0020	31-235D-0020	MBT/Hk Distal
L5/OB	-17°	2°	0°	31-1450-0073	31-1350-0073	31-2450-0073	31-2350-0073	MBT/Offset Base
L5/OB/Hk	-17°	2°	0°	31-145D-0073	31-135D-0073	31-245D-0073	31-235D-0073	MBT/Offset Base/Hk
L5	-22°	0°	0°	31-1650-0015	31-1645-0015	31-2650-0015	31-2650-0015	AND/Universal
L5	-22°	-1°	4°d	31-1450-0010	31-1350-0010	31-2450-0010	31-2350-0010	ROTH
L5/Hk	-22°	-1°	4°d	31-145D-0010	31-135D-0010	31-245D-0010	31-235D-0010	ROTH/Hk Distal
L5/OB	-22°	0°	0°	31-1650-0013	31-1650-0013	31-2650-0013	31-2650-0013	ROTH/Offset Base
L5/OB/Hk	-22°	0°	0°	31-145D-0013	31-135D-0013	31-245D-0013	31-235D-0013	ROTH/Offset Base/Hk

LEGEND Mini

LEGEND Mini V-SLOT

CHART IDENTIFICATION
BALL HOOK
OPTION
OFFSET BASE

Maxillary				Part Numbers				Notes
Tooth	Torque	Angulation	Rotation	018R	018L	022R	022L	
U1	12°	5°	0°	31-1110-0034	31-1210-0034	31-2110-0034	31-2210-0034	
U2	8°	9°	0°	31-1120-0034	31-1220-0034	31-2120-0034	31-2220-0034	
U3	-2°	7°	0°	31-1130-0034	31-1230-0034	31-2130-0034	31-2230-0034	
U3/Hk	-2°	7°	0°	31-113D-0034	31-123D-0034	31-213D-0034	31-223D-0034	Hk Distal
U4-5	-7°	0°	0°	31-1540-0034	31-1540-0034	31-2540-0034	31-2540-0034	Universal
U4-5/Hk	-7°	0°	0°	31-114M-0034	31-124M-0034	31-214M-0034	31-224M-0034	Hk Mesial
U4-5/OB	-7°	0°	0°	31-1540-0035	31-1540-0035	31-2540-0035	31-2540-0035	Offset Base/Universal

Mandibular				Part Numbers				Notes
Tooth	Torque	Angulation	Rotation	018R	018L	022R	022L	
L1-2	0°	0°	0°	31-1610-0034	31-1610-0034	31-2610-0034	31-2610-0034	Universal
L3	-5°	7°	0°	31-1430-0034	31-1330-0034	31-2430-0034	31-2330-0034	
L3/Hk	-5°	7°	0°	31-143D-0034	31-133D-0034	31-243D-0034	31-233D-0034	Hk Distal
L4	-11°	0°	0°	31-1640-0034	31-1640-0034	31-2640-0034	31-2640-0034	Universal
L4/Hk	-11°	0°	0°	31-144D-0034	31-134D-0034	31-244D-0034	31-234D-0034	Hk Distal
L5	-17°	0°	0°	31-1650-0034	31-1650-0034	31-2650-0034	31-2650-0034	Universal
L5/Hk	-17°	0°	0°	31-145D-0034	31-135D-0034	31-245D-0034	31-235D-0034	Hk Distal
L4/OB	-11°	0°	0°	31-1640-0035	31-1640-0035	31-2640-0035	31-2640-0035	Offset Base/Universal
L4/OB/Hk	-11°	0°	0°	31-144D-0035	31-134D-0035	31-244D-0035	31-234D-0035	Offset Base/Hk Distal
L5/OB	-17°	0°	0°	31-1650-0035	31-1650-0035	31-2650-0035	31-2650-0035	Offset Base/Universal
L5/OB/Hk	-17°	0°	0°	31-145D-0035	31-135D-0035	31-245D-0035	31-235D-0035	Offset Base/Hk Distal



Single Patient Kits				Part Numbers		Notes
Rx	Upper Arch	Lower Arch	Hooks	018	022	
V-Slot	5-5	5-5	—	—	31-2CC0-0034	No hooks
V-Slot	5-5	5-5	3	—	31-2CC3-0034	Hooks on 3's only
V-Slot	5-5	5-5	U3, L3,4	—	31-2C34-0034	Hooks on U3, L3,4
V-Slot	5-5	5-5	3,4	—	31-2CC4-0034	Hooks on 3,4
V-Slot	5-5	5-5	3,4,5	—	31-2CC5-0034	Hooks on 3,4,5

Now also available in Rhodium 



Color Codes





**CHART
IDENTIFICATION
BALL HOOK**

LEGEND Mini V-SLOT Bidimensional

Maxillary				Part Numbers				Notes
Tooth	Torque	Angulation	Rotation	018R	018L	022R	022L	
U1	12°	5°	0°	31-1110-0034	31-1210-0034	—	—	
U2	8°	9°	0°	31-1120-0034	31-1220-0034	—	—	
U3	0°	7°	0°	—	—	31-2130-0040	31-2230-0040	
U3/Hk	0°	7°	0°	—	—	31-213D-0040	31-223D-0040	Hk Distal
U4-5	0°	0°	0°	—	—	31-2540-0040	31-2540-0040	Universal
U4-5/Hk	0°	0°	0°	—	—	31-215M-0040	31-225M-0040	Hk Mesial

Mandibular				Part Numbers				Notes
Tooth	Torque	Angulation	Rotation	018R	018L	022R	022L	
L1-2	0°	0°	0°	31-1610-0034	31-1610-0034	—	—	Universal
L3	0°	5°	0°	—	—	31-2430-0040	31-2330-0040	
L3/Hk	0°	5°	0°	—	—	31-243D-0040	31-233D-0040	Hk Distal
L4-5	0°	0°	0°	—	—	31-2640-0040	31-2640-0040	Universal
L4-5/Hk	0°	0°	0°	—	—	31-244D-0040	31-234D-0040	Hk Distal



Single Patient Kits				Part Numbers	Notes
Rx	Upper Arch	Lower Arch	Hooks	BIDIMENSIONAL	
V-Slot	5-5	5-5	3	31-BID3-0034	Hooks on 3's only



Color Codes



LEGEND Mini

LEGEND Mini Alexander

CHART IDENTIFICATION
BALL HOOK
OFFSET BASE

Maxillary				Part Numbers				Notes
Tooth	Torque	Angulation	Rotation	018R	018L	022R	022L	
U1	14°	5°	0°	31-1110-0031	31-1210-0031	31-2110-0031	31-2210-0031	Twin
U2	7°	9°	0°	31-1120-0031	31-1220-0031	31-2120-0031	31-2220-0031	Twin
U2/Hk	8°	9°	0°	31-112D-0010	31-122D-0010	31-212D-0010	31-222D-0010	Twin/Hk Distal
U3/Lewis (sw)	-3°	10°	0°	31-1130-0031	31-1230-0031	31-2130-0031	31-2230-0031	Lewis
U3/Hk (sw)	-3°	10°	0°	31-113U-0031	31-123U-0031	31-213U-0031	31-223U-0031	Lewis/Hk Centered
U4/Lewis	-7°	0°	0°	31-1540-0031	31-1540-0031	31-2540-0031	31-2540-0031	Universal
U4/Hk (sw)	-7°	0°	0°	31-154U-0031	31-154U-0031	31-254U-0031	31-254U-0031	Hk Universal
U5 (sw)	-8°	4°	0°	31-1150-0031	31-1250-0031	31-2150-0031	31-2250-0031	
U5/Hk (sw)	-8°	4°	0°	31-115U-0031	31-125U-0031	31-215U-0031	31-225U-0031	Hk Centered
U4/OB	-7°	0°	0°	31-1540-0032	31-1540-0032	31-2540-0032	31-2540-0032	Offset Base/Universal
U4/OB/Hk	-7°	0°	0°	31-154U-0032	31-154U-0032	31-254U-0032	31-254U-0032	Offset Base/Hk Univ
U5/OB	-8°	4°	0°	31-1150-0032	31-1250-0032	31-2150-0032	31-2250-0032	Offset Base
U5/OB/Hk	-8°	4°	0°	31-115U-0032	31-125U-0032	31-215U-0032	31-225U-0032	Offset Base/Hk
U4-5/OB/Hk	0°	0°	0°	31-154U-0043	31-154U-0043	31-254U-0043	31-254U-0043	Offset Base/Hk Univ

Mandibular				Part Numbers				Notes
Tooth	Torque	Angulation	Rotation	018R	018L	022R	022L	
L1/Lewis (sw)	-5°	2°	0°	31-1410-0046	31-1310-0046	31-2410-0046	31-2310-0046	
L2/Lewis (sw)	-5°	6°	0°	31-1420-0046	31-1320-0046	31-2420-0046	31-2320-0046	
L2/Hk (sw)	-5°	6°	0°	31-142U-0046	31-132U-0046	31-242U-0046	31-232U-0046	Hk Centered
U3/Lewis (sw)	-7°	6°	0°	31-1430-0031	31-1330-0031	31-2430-0031	31-2330-0031	
L3/Hk (sw)	-7°	6°	0°	31-143U-0031	31-133U-0031	31-243U-0031	31-233U-0031	Hk Centered
L4 (sw)	-7°	0°	0°	31-1640-0033	31-1640-0033	31-2640-0033	31-2640-0033	Universal
L4/Hk (sw)	-7°	0°	0°	31-164U-0033	31-164U-0033	31-264U-0033	31-264U-0033	Hk Universal
L5 (sw)	-9°	0°	0°	31-1650-0033	31-1650-0033	31-2650-0033	31-2650-0033	Universal
L5/Hk (sw)	-9°	0°	0°	31-165U-0033	31-165U-0033	31-265U-0033	31-265U-0033	Hk Universal
L4/OB	-7°	0°	0°	31-1640-0048	31-1640-0048	31-2640-0048	31-2640-0048	Offset Base/Universal
L4/OB/Hk	-7°	0°	0°	31-164U-0048	31-164U-0048	31-264U-0048	31-264U-0048	Offset Base/Hk Univ
L5/OB	-9°	0°	0°	31-1650-0048	31-1650-0048	31-2650-0048	31-2650-0048	Offset Base/Universal
L5/OB/Hk	-9°	0°	0°	31-165U-0048	31-165U-0048	31-265U-0048	31-265U-0048	Offset Base/Hk Univ
L4-5/OB/Hk	0°	0°	0°	31-164U-0043	31-164U-0043	31-264U-0043	31-264U-0043	Offset Base/Hk Univ



Color Codes

UR	UL
LR	LL



LEGEND Mini Single Wing

CHART IDENTIFICATION
BALL HOOK
OPTION
OFFSET BASE

Maxillary				Part Numbers				Notes
Tooth	Torque	Angulation	Rotation	018R	018L	022R	022L	
U1	14°	5°	0°	31-1110-0031	31-1210-0031	31-2110-0031	31-2210-0031	Twin
U2	7°	9°	0°	31-1120-0031	31-1220-0031	31-2120-0031	31-2220-0031	Twin
U2/Hk	8°	9°	0°	31-112D-0010	31-122D-0010	31-212D-0010	31-222D-0010	Twin/Hk Distal
U3/Lewis (sw)	-3°	10°	0°	31-1130-0031	31-1230-0031	31-2130-0031	31-2230-0031	Lewis
U3/Hk (sw)	-3°	10°	0°	31-113U-0031	31-123U-0031	31-213U-0031	31-223U-0031	Lewis/Hk Centered
U4/Lewis	-7°	0°	0°	31-1540-0031	31-1540-0031	31-2540-0031	31-2540-0031	Universal
U4/Hk (sw)	-7°	0°	0°	31-154U-0031	31-154U-0031	31-254U-0031	31-254U-0031	Hk Universal
U5 (sw)	-7°	0°	0°	31-1550-0031	31-1550-0031	31-2550-0031	31-2550-0031	Universal
U5/Hk (sw)	-7°	0°	0°	31-155U-0031	31-155U-0031	31-255U-0031	31-255U-0031	Hk Universal
U4-5/OB	-7°	0°	0°	31-1540-0032	31-1540-0032	31-2540-0032	31-2540-0032	Offset Base/Universal
U4-5/OB/Hk	-7°	0°	0°	31-154U-0032	31-154U-0032	31-254U-0032	31-254U-0032	Offset Base/Hk Univ

Mandibular				Part Numbers				Notes
Tooth	Torque	Angulation	Rotation	018R	018L	022R	022L	
L1-2/Lewis (sw)	-5°	0°	0°	31-1610-0031	31-1610-0031	31-2610-0031	31-2610-0031	Universal
L1-2/Hk (sw)	-5°	0°	0°	31-161U-0031	31-161U-0031	31-261U-0031	31-261U-0031	Hk Universal
L1-2 (sw) Opt	-1°	0°	0°	31-1610-0033	31-1610-0033	31-2610-0033	31-2610-0033	Option
L1-2/Hk (sw)	-1°	0°	0°	31-161U-0033	31-161U-0033	—	—	Option/Hk Universal
U3/Lewis (sw)	-7°	6°	0°	31-1430-0031	31-1330-0031	31-2430-0031	31-2330-0031	
L3/Hk (sw)	-7°	6°	0°	31-143U-0031	31-133U-0031	31-243U-0031	31-233U-0031	Hk Centered
L3 (sw) Opt	0°	6°	0°	31-1430-0033	31-1330-0033	—	—	Option
L4 (sw)	-11°	0°	0°	31-1640-0031	31-1640-0031	31-2640-0031	31-2640-0031	Universal
L4/Hk (sw)	-11°	0°	0°	31-164U-0031	31-164U-0031	31-264U-0031	31-264U-0031	Hk Universal
L5 (sw)	-17°	0°	0°	31-1650-0031	31-1650-0031	31-2650-0031	31-2650-0031	Universal
L5/Hk (sw)	-17°	0°	0°	31-165U-0031	31-165U-0031	31-265U-0031	31-265U-0031	Hk Universal
L4/OB	-11°	0°	0°	31-1640-0032	31-1640-0032	31-2640-0032	31-2640-0032	Offset Base/Universal
L4/OB/Hk	-11°	0°	0°	31-164U-0032	31-164U-0032	31-264U-0032	31-264U-0032	Offset Base/Hk Univ
L5/OB	-17°	0°	0°	31-1650-0032	31-1650-0032	31-2650-0032	31-2650-0032	Offset Base/Universal
L5/OB/Hk	-17°	0°	0°	31-165U-0032	31-165U-0032	31-265U-0032	31-265U-0032	Offset Base/Hk Univ



Color Codes

UR	UL
LR	LL

LEGEND Medium

LEGEND Medium Roth

CHART IDENTIFICATION
BALL HOOK
OPTION
OFFSET BASE

Maxillary				Part Numbers				Notes
Tooth	Torque	Angulation	Rotation	018R	018L	022R	022L	
U1	12°	5°	0°	32-1110-0010	32-1210-0010	32-2110-0010	32-2210-0010	
U2	8°	9°	0°	32-1120-0010	32-1220-0010	32-2120-0010	32-2220-0010	
U2/Hk	8°	9°	0°	—	—	32-212D-0010	32-222D-0010	Hk Distal
U3	-2°	10°	0°	32-1130-0010	32-1230-0010	32-2130-0010	32-2230-0010	
U3/Hk	-2°	10°	0°	32-113D-0010	32-123D-0010	32-213D-0010	32-223D-0010	Hk Distal
U4	-7°	0°	0°	32-1540-0010	32-1540-0010	32-2540-0010	32-2540-0010	Universal
U4/Hk M	-7°	0°	0°	32-114M-0010	32-124M-0010	32-214M-0010	32-224M-0010	Hk Mesial
U4-5/Hk D	-7°	0°	0°	32-114D-0020	32-124D-0020	32-214D-0020	32-224D-0020	Hk Distal (Opt)
U5	-7°	0°	0°	32-1550-0010	32-1550-0010	32-2550-0010	32-2550-0010	Universal
U5/Hk	-7°	0°	0°	32-115M-0010	32-125M-0010	32-215M-0010	32-225M-0010	Hk Mesial
U4-5/OB	-7°	0°	0°	32-1540-0013	32-1540-0013	32-2540-0013	32-2540-0013	Offset Base/Universal
U4-5/OB/Hk	-7°	0°	0°	32-114M-0013	32-124M-0013	32-214M-0013	32-224M-0013	Offset Base/Hk Mesial

Mandibular				Part Numbers				Notes
Tooth	Torque	Angulation	Rotation	018R	018L	022R	022L	
L1-2	-1°	0°	0°	32-1610-0010	32-1610-0010	32-2610-0010	32-2610-0010	Universal
L2/Hk (D)	-1°	0°	0°	32-141D-0010	32-131D-0010	32-241D-0010	32-231D-0010	Hk Distal
L3	-11°	7°	0°	32-1430-0010	32-1330-0010	32-2430-0010	32-2330-0010	
L3/Hk	-11°	7°	0°	32-143D-0010	32-133D-0010	32-243D-0010	32-233D-0010	Hk Distal
L4	-17°	0°	0°	32-1640-0010	32-1640-0010	32-2640-0010	32-2640-0010	
L4/Hk	-17°	0°	0°	32-144D-0010	32-134D-0010	32-244D-0010	32-234D-0010	Hk Distal
L5	-22°	0°	0°	32-1650-0010	32-1650-0010	32-2650-0010	32-2650-0010	
L5/Hk	-22°	0°	0°	32-145D-0010	32-135D-0010	32-245D-0010	32-235D-0010	Hk Distal
L4/OB	-17°	0°	0°	32-1640-0013	32-1640-0013	32-2640-0013	32-2640-0013	Offset Base/Universal
L4/OB/Hk	-17°	0°	0°	32-144D-0013	32-134D-0013	32-244D-0013	32-234D-0013	Offset Base/Hk Distal
L5/OB	-22°	0°	0°	32-1650-0013	32-1650-0013	32-2650-0013	32-2650-0013	Offset Base/Universal
L5/OB/Hk	-22°	0°	0°	32-145D-0013	32-135D-0013	32-245D-0013	32-235D-0013	Offset Base/Hk Distal



Single Patient Kits				Part Numbers		Notes
Rx	Upper Arch	Lower Arch	Hooks	018	022	
Roth	5-5	5-5	—	—	32-2CC0-0010	No hooks
Roth	5-5	5-5	3	32-1CC3-0010	32-2CC3-0010	Hooks on 3's only
Roth	5-5	5-5	3,4	32-1CC4-0010	32-2CC4-0010	Hooks on 3,4
Roth	5-5	5-5	3,4,5	32-1CC5-0010	32-2CC5-0010	Hooks on 3,4,5



Color Codes





LEGEND Medium MBT

CHART IDENTIFICATION
BALL HOOK
OPTION
OFFSET BASE

Maxillary				Part Numbers				Notes
Tooth	Torque	Angulation	Rotation	018R	018L	022R	022L	
U1	17°	4°	0°	32-1110-0020	32-1210-0020	32-2110-0020	32-2210-0020	
U2	10°	8°	0°	32-1120-0020	32-1220-0020	32-2120-0020	32-2220-0020	
U3	-7°	8°	0°	—	—	32-2130-0020	32-2230-0020	
U3/Hk	-7°	8°	0°	32-113D-0020	32-123D-0020	32-213D-0020	32-223D-0020	Hk Distal
U3/Hk(Opt)	0°	8°	0°	32-113D-0021	32-123D-0021	32-213D-0021	32-223D-0021	Hk Distal
U4	-7°	0°	0°	32-1540-0020	32-1540-0020	32-2540-0020	32-2540-0020	Universal
U4/Hk	-7°	0°	0°	32-114D-0020	32-124D-0020	32-214D-0020	32-224D-0020	Hk Distal
U5	-7°	0°	0°	32-1550-0020	32-1550-0020	32-2550-0020	32-2550-0020	Universal
U4/Hk M	-7°	0°	0°	32-114M-0020	32-124M-0020	32-214M-0020	32-224M-0020	Hk Mesial
U5/Hk	-7°	0°	0°	32-115D-0010	32-125D-0020	32-215D-0020	32-225D-0020	Hk Distal
U5/Hk M	-7°	0°	0°	32-115M-0020	32-125M-0020	32-215M-0020	32-225M-0020	Hk Mesial
U4-5/OB	-7°	0°	0°	32-1540-0013	32-1540-0013	32-2540-0013	32-2540-0013	Offset Base/Universal
U4-5/OB/Hk	-7°	0°	0°	32-114M-0013	32-124M-0013	32-214M-0013	32-224M-0013	Offset Base/Hk Mesial

Mandibular				Part Numbers				Notes
Tooth	Torque	Angulation	Rotation	018R	018L	022R	022L	
L1-2	-6°	0°	0°	32-1610-0020	32-1610-0020	32-2610-0020	32-2610-0020	Universal
L3	-6°	7°	0°	—	—	32-2430-0020	32-2330-0020	
L3/Hk	-6°	3°	0°	32-143D-0020	32-133D-0020	32-243D-0020	32-233D-0020	Hk Distal
L3/Hk(Opt)	0°	3°	0°	32-143D-0021	32-133D-0021	32-243D-0021	32-233D-0021	Hk Distal
L4	-12°	2°	0°	32-1440-0020	32-1340-0020	32-2440-0020	32-2340-0020	
L4/Hk	-12°	2°	0°	32-144D-0020	32-134D-0020	32-244D-0020	32-234D-0020	Hk Distal
L5	-17°	2°	0°	32-1450-0020	32-1350-0020	32-2450-0020	32-2350-0020	
L5/Hk	-17°	2°	0°	32-145D-0020	32-135D-0020	32-245D-0020	32-235D-0020	Hk Distal
L4/OB	-12°	2°	0°	32-1440-0073	32-1340-0073	32-2440-0073	32-2340-0073	Offset Base
L4/OB/Hk	-12°	2°	0°	32-144D-0073	32-134D-0073	32-244D-0073	32-234D-0073	Offset Base/Hk Distal
L5/OB	-17°	2°	0°	32-1450-0073	32-1350-0073	32-2450-0073	32-2350-0073	Offset Base
L5/OB/Hk	-17°	2°	0°	32-145D-0073	32-135D-0073	32-245D-0073	32-235D-0073	Offset Base/Hk Distal



Single Patient Kits				Part Numbers			Notes
Rx	Upper Arch	Lower Arch	Hooks	018	022		
MBT	5-5	5-5	3	32-1CC3-0020	32-2CC3-0020		Hooks on 3's only
MBT	5-5	5-5	3,4	32-1CC4-0020	32-2CC4-0020		Hooks on 3,4
MBT	5-5	5-5	3,4,5	32-1CC5-0020	32-2CC5-0020		Hooks on 3,4,5



Color Codes



LEGEND Medium

LEGEND Medium Andrews

CHART IDENTIFICATION
BALL HOOK
OPTION

Maxillary				Part Numbers				Notes
Tooth	Torque	Angulation	Rotation	018R	018L	022R	022L	
U1	7°	5°	0°	---	---	32-2110-0015	32-2210-0015	
U2	3°	9°	0°	---	---	32-2120-0015	32-2220-0015	
U3/Hk	-7°	8°	0°	32-113D-0020	32-123D-0020	32-213D-0020	32-223D-0020	Hk Distal
U4	-7°	0°	0°	32-1540-0010	32-1540-0010	32-2540-0010	32-2540-0010	Universal
U4/Hk M	-7°	0°	0°	32-114M-0010	32-124M-0010	32-214M-0010	32-224M-0010	Hk Mesial
U4-5/Hk D	-7°	0°	0°	32-114D-0020	32-124D-0020	32-214D-0020	32-224D-0020	Hk Distal (Opt)
U5	-7°	0°	0°	32-1550-0010	32-1550-0010	32-2550-0010	32-2550-0010	Universal
U5/Hk	-7°	0°	0°	32-115M-0010	32-125M-0010	32-215M-0010	32-225M-0010	Hk Mesial

Mandibular				Part Numbers				Notes
Tooth	Torque	Angulation	Rotation	018R	018L	022R	022L	
L1-2	-6°	0°	0°	32-1610-0020	32-1610-0020	32-2610-0020	32-2610-0020	Universal
L2(Opt)	-1°	0°	0°	32-1610-0010	32-1610-0010	32-2610-0010	32-2610-0010	
L3	-11°	7°	0°	32-1430-0010	32-1330-0010	32-2430-0010	32-2330-0010	
L3/Hk	-11°	5°	0°	---	---	32-243D-0015	32-233D-0015	Hk Distal
L4	-17°	0°	0°	32-1640-0010	32-1640-0010	32-2640-0010	32-2640-0010	
L4/Hk	-17°	0°	0°	32-144D-0010	32-134D-0010	32-244D-0010	32-234D-0010	Hk Distal
L5	-22°	0°	0°	32-1650-0010	32-1650-0010	32-2650-0010	32-2650-0010	
L5/Hk	-22°	0°	0°	32-145D-0010	32-135D-0010	32-245D-0010	32-235D-0010	Hk Distal

LEGEND Medium Polar

Maxillary				Part Numbers				Notes
Tooth	Torque	Angulation	Rotation	018R	018L	022R	022L	
U1	20°	3°	0°	32-1110-0022	32-1210-0022	---	---	
U2	14°	9°	0°	32-1120-0022	32-1220-0022	---	---	
U3/Hk	-2°	6°	0°	32-113D-0022	32-123D-0022	---	---	Hk Distal
U4-5	-10°	2°	0°	32-1140-0022	32-1240-0022	---	---	

Mandibular				Part Numbers				Notes
Tooth	Torque	Angulation	Rotation	018R	018L	022R	022L	
L1-2	0°	0°	0°	32-1610-0022	32-1610-0022	---	---	Universal
L3/Hk	0°	5°	0°	32-143D-0022	32-133D-0022	---	---	Hk Distal
L4	-10°	2°	0°	32-1440-0022	32-1340-0022	---	---	
L4/Hk	-15°	2°	0°	32-1450-0022	32-1350-0022	---	---	Hk Distal



Color Codes





LEGEND Medium Bioprogressive

CHART IDENTIFICATION
BALL HOOK
OPTION

Maxillary				Part Numbers				Notes
Tooth	Torque	Angulation	Rotation	018R	018L	022R	022L	
U1	22°	5°	0°	32-1110-0027	31-1210-0027	32-2110-0027	32-2210-0027	
U2	14°	9°	0°	32-1120-0027	32-1220-0027	32-2120-0027	32-2220-0027	
U3	7°	5°	0°	32-1130-0027	32-1230-0027	—	—	
U3/Hk	-7°	5°	0°	32-113D-0027	32-123D-0027	32-213D-0027	32-223D-0027	Hk Distal
U4-5	0°	0°	0°	32-1540-0027	32-1540-0027	—	—	Universal
U4/Hk	0°	0°	0°	32-114M-0027	32-124M-0027	—	—	Hk Mesial
U4-5 (Opt)	-7°	0°	0°	32-1540-0029	32-1540-0029	—	—	Universal

Mandibular				Part Numbers				Notes
Tooth	Torque	Angulation	Rotation	018R	018L	022R	022L	
L1-2	-1°	0°	0°	32-1610-0010	32-1610-0010	32-2610-0010	32-2610-0010	Universal
L3	7°	5°	0°	32-1430-0027	32-1330-0027	—	—	
L3/Hk	7°	5°	0°	32-143D-0027	32-133D-0027	—	—	Hk Distal
L4	0°	0°	0°	32-1640-0027	32-1640-0027	—	—	Universal
L4/Hk	0°	0°	0°	32-144D-0027	32-134D-0027	—	—	Hk Distal
L4 (Opt)	-11°	0°	0°	32-1640-0029	32-1640-0029	—	—	Universal
L5 (Opt)	-17°	0°	0°	32-1650-0029	32-1650-0029	—	—	Universal



Color Codes



LEGEND Medium XT

Maxillary				Part Numbers				Notes
Tooth	Torque	Angulation	Rotation	018R	018L	022R	022L	
U1	18°	5°	0°	32-1110-0030	32-1210-0030	32-2110-0030	32-2210-0030	
U2	10°	8°	0°	32-1120-0030	32-1220-0030	32-2120-0030	32-2220-0030	
U2/Hk	10°	8°	0°	32-112D-0030	32-122D-0030	32-212D-0030	32-222D-0030	Hk Distal
U3/Hk	0°	8°	2°m	32-113D-0030	32-123D-0030	32-213D-0030	32-223D-0030	Hk Distal
U4-5	-10°	4°	2°d	32-1140-0030	32-1240-0030	32-2140-0030	32-2240-0030	
U4-5/Hk	-10°	4°	2°d	32-114M-0030	32-124M-0030	32-214M-0030	32-224M-0030	Hk Mesial

Mandibular				Part Numbers				Notes
Tooth	Torque	Angulation	Rotation	018R	018L	022R	022L	
L1-2	1°	0°	0°	32-1610-0030	32-1610-0030	32-2610-0030	32-2610-0030	Universal
L1-2 (Opt)	-5°	0°	0°	32-1610-0011	32-1610-0011	32-2610-0011	32-2610-0011	Universal
L3	-3°	7°	2°m	32-1430-0030	32-1330-0030	—	—	
L3/Hk	-3°	7°	2°m	32-143D-0030	32-133D-0030	32-243D-0030	32-233D-0030	Hk Distal
L4	-7°	-1°	2°d	32-1440-0030	32-1340-0030	32-2440-0030	32-2340-0030	
L4/Hk	-7°	-1°	2°d	32-144D-0030	32-134D-0030	32-244D-0030	32-234D-0030	Hk Distal

LEGEND Medium

LEGEND Medium Complete Bracket Options - Upper

Maxillary				Part Numbers				Notes
Tooth	Torque	Angulation	Rotation	018R	018L	022R	022L	
U1	7°	5°	0°	—	—	32-2110-0015	32-2210-0015	AND
U1	12°	5°	0°	32-1110-0010	32-1210-0010	32-2110-0010	32-2210-0010	ROTH
U1	17°	4°	0°	32-1110-0020	32-1210-0020	32-2110-0020	32-2210-0020	MBT
U1	17°	5°	0°	—	—	32-2110-0011	32-2210-0011	XTQ
U1	18°	5°	0°	32-1110-0030	32-1210-0030	32-2110-0030	32-2210-0030	XT
U1	20°	3°	0°	32-1110-0022	32-1210-0022	32-2110-0022	32-2210-0022	POLAR
U1	22°	5°	0°	32-1110-0027	32-1210-0027	32-2110-0027	32-2210-0027	BIO/HT
U2	3°	9°	0°	—	—	32-2120-0015	32-2220-0015	AND
U2	8°	9°	0°	32-1120-0010	32-1220-0010	32-2120-0010	32-2220-0010	ROTH
U2/Hk	8°	9°	0°	—	—	32-212D-0010	32-222D-0010	ROTH/Hk Distal
U2	10°	8°	0°	32-1120-0020	32-1220-0020	32-2120-0020	32-2220-0020	MBT
U2	10°	8°	0°	32-1120-0030	32-1220-0030	32-2120-0030	32-2220-0030	XT
U2/Hk	10°	8°	0°	32-112D-0030	32-122D-0030	32-212D-0030	32-222D-0030	XT/Hk Distal
U2	14°	9°	0°	32-1120-0027	32-1220-0027	32-2120-0027	32-2220-0027	BIO
U2	14°	9°	0°	32-1120-0022	32-1220-0022	—	—	POLAR
U3	7°	5°	0°	32-1130-0027	32-1230-0027	—	—	BIO
U3/Hk	7°	5°	0°	32-113D-0027	32-123D-0027	32-213D-0027	32-223D-0027	BIO/Hk Distal
U3/Hk	0°	8°	0°	32-113D-0021	32-123D-0021	32-213D-0021	32-223D-0021	MBT/Hk Distal
U3/Hk	0°	8°	2°m	32-113D-0030	32-123D-0030	32-213D-0030	32-223D-0030	XT/Hk Distal
U3/Hk	-2°	6°	0°	32-113D-0022	32-123D-0022	—	—	POLAR/Hk Distal
U3	-2°	10°	0°	32-1130-0010	32-1230-0010	32-2130-0010	32-2230-0010	ROTH
U3/Hk	-2°	10°	0°	32-113D-0010	32-123D-0010	32-213D-0010	32-223D-0010	ROTH/Hk Distal
U3/Hk	-3°	7°	0°	—	—	32-213D-0075	32-223D-0075	APA/Hk Distal
U3	-7°	8°	0°	—	—	32-2130-0020	32-2230-0020	MBT
U3/Hk	-7°	8°	0°	32-113D-0020	32-123D-0020	32-213D-0020	32-223D-0020	MBT/Hk Distal
U4-5	0°	0°	0°	32-1540-0027	32-1540-0027	—	—	BIO/Universal
U4-5/Hk	0°	0°	0°	32-114M-0027	32-124M-0027	—	—	BIO/Hk Mesial
U4-5	-7°	0°	0°	32-1540-0029	32-1540-0029	—	—	BIO/Universal
U4	-7°	0°	0°	32-1540-0010	32-1540-0010	32-2540-0010	32-2540-0010	ROTH/Universal
U4/Hk M	-7°	0°	0°	32-114M-0010	32-124M-0010	32-214M-0010	32-224M-0010	ROTH/Hk Mesial
U4	-7°	0°	0°	32-1540-0020	32-1540-0020	32-2540-0020	32-2540-0020	MBT/Hk Mesial
U4/Hk D	-7°	0°	0°	32-114D-0020	32-124D-0020	32-214D-0020	32-224D-0020	MBT/Hk Distal
U4/Hk M	-7°	0°	0°	32-114M-0020	32-124M-0020	32-214M-0020	32-224M-0020	MBT/Hk Mesial
U4-5	-7°	0°	0°	32-1540-0011	32-1540-0011	—	—	XTQ/Universal
U4-5	-10°	2°	0°	32-1140-0022	32-1240-0022	—	—	POLAR
U4-5	-10°	4°	2°d	32-1140-0030	32-1240-0030	32-2140-0030	32-2240-0030	XT/Universal
U4-5/Hk	-10°	4°	2°d	32-114M-0030	32-124M-0030	32-214M-0030	32-224M-0030	XT/Hk Mesial
U5	-7°	0°	0°	32-1550-0010	32-1550-0010	32-2550-0010	32-2550-0010	ROTH/Universal
U5/Hk	-7°	0°	0°	32-115M-0010	32-125M-0010	32-215M-0010	32-225M-0010	ROTH/Hk Mesial
U5	-7°	0°	0°	32-1550-0020	32-1550-0020	32-2550-0020	32-2550-0020	MBT/Universal
U5/Hk	-7°	0°	0°	32-115D-0020	32-125D-0020	32-215D-0020	32-225D-0020	MBT/Hk Distal
U5/Hk M	-7°	0°	0°	32-115M-0020	32-125M-0020	32-215M-0020	32-225M-0020	MBT/Hk Mesial
U4-5/OB	-7°	0°	0°	32-1540-0013	32-1540-0013	32-2540-0013	32-2540-0013	Offset Base/Universal
U4-5/OB/Hk	-7°	0°	0°	32-114M-0013	32-124M-0013	32-214M-0013	32-224M-0013	Offset Base/Hk Mesial



LEGEND Medium Complete Bracket Options - Lower

Mandibular				Part Numbers				Notes
Tooth	Torque	Angulation	Rotation	018R	018L	022R	022L	
L1-2	1°	0°	0°	32-1610-0030	32-1610-0030	32-2610-0030	32-2610-0030	XT/Universal
L1-2	0	0°	0°	32-1610-0022	32-1610-0022	—	—	POLAR/Universal
L1-2	-1°	0°	0°	32-1610-0010	32-1610-0010	32-2610-0010	32-2610-0010	ROTH/BIO/Universal
L2/Hk (D)	-1°	0°	0°	32-141D-0010	32-131D-0010	32-241D-0010	32-231D-0010	ROTH/Hk Distal
L1-2	-5°	0°	0°	32-1610-0011	32-1610-0011	32-2610-0011	32-2610-0011	XT/Universal
L1-2	-6°	0°	0°	32-1610-0020	32-1610-0020	32-2610-0020	32-2610-0020	MBT/AND/Universal
L1-2	-6°	0°	0°	—	—	32-2610-0026	32-2610-0026	XTQ/Universal
L3	7°	5°	0°	32-1430-0027	32-1330-0027	—	—	BIO
L3/Hk	7°	5°	0°	32-143D-0027	32-133D-0027	—	—	BIO/Hk Distal
L3/Hk	0°	3°	0°	32-143D-0021	32-133D-0021	32-243D-0021	32-233D-0021	MBT/Hk Distal
L3/Hk	0°	5°	0°	32-143D-0022	32-133D-0022	—	—	POLAR
L3	-3°	7°	2°m	32-1430-0030	32-1330-0030	—	—	XT
L3	-3°	7°	2°m	32-143D-0030	32-133D-0030	—	—	XT/Hk Distal
L3/Hk	-6°	3°	0°	—	—	32-2430-0020	32-2330-0020	MBT
L3/Hk	-6°	3°	0°	32-143D-0020	32-133D-0020	32-243D-0020	32-233D-0020	MBT/Hk Distal
L3/Hk	-11°	5°	0°	—	—	32-243D-0015	32-233D-0015	AND
L3	-11°	7°	2°m	32-1430-0010	32-1330-0010	32-2430-0010	32-2330-0010	ROTH
L3/Hk	-11°	7°	2°m	32-143D-0010	32-133D-0010	32-243D-0010	32-233D-0010	ROTH/Hk Distal
L4-5	0°	0°	0°	32-1640-0027	32-1640-0027	—	—	BIO/Universal
L4-5/HK	0°	0°	0°	32-144D-0027	32-134D-0027	—	—	BIO/Hk Distal
L4-5	-7°	-1°	2°d	32-1440-0030	32-1340-0030	32-2440-0030	32-2340-0030	XT/Universal
L4-5/Hk	-7°	-1°	2°d	32-144D-0030	32-134D-0030	32-244D-0030	32-234D-0030	XT/Hk Distal
L4	-10°	2°	0°	32-1440-0022	32-1340-0022	—	—	POLAR
L4	-11°	0°	0°	32-1640-0029	32-1640-0029	—	—	BIO/Universal
L4	-12°	2°	0°	32-1440-0020	32-1340-0020	32-2440-0020	32-2340-0020	MBT
L4/Hk	-12°	2°	0°	32-144D-0020	32-134D-0020	32-244D-0020	32-234D-0020	MBT/Hk Distal
L4/OB	-12°	2°	0°	32-1440-0073	32-1340-0073	32-2440-0073	32-2340-0073	MBT/Offset Base
L4/OB/Hk	-12°	2°	0°	32-144D-0073	32-134D-0073	32-244D-0073	32-234D-0073	MBT/Offset Base/Hk D
L4/OB	-17°	0°	0°	32-1640-0013	32-1640-0013	32-2640-0013	32-2640-0013	Offset Base/Universal
L4/OB/Hk	-17°	0°	0°	32-144D-0013	32-134D-0013	32-244D-0013	32-234D-0013	ROTH/Offset Bs/Hk D
L4	-17°	0°	0°	32-1640-0010	32-1640-0010	32-2640-0010	32-2640-0010	ROTH/Universal
L4/Hk	-17°	0°	0°	32-144D-0010	32-134D-0010	32-244D-0010	32-234D-0010	ROTH/Hk Distal
L5	-15°	2°	0°	32-1450-0022	32-1350-0022	—	—	POLAR
L5	-17°	0°	0°	32-1650-0029	32-1650-0029	—	—	BIO
L5	-17°	2°	0°	32-1450-0020	32-1350-0020	32-2450-0020	32-2350-0020	MBT
L5/Hk	-17°	2°	0°	32-145D-0020	32-135D-0020	32-245D-0020	32-235D-0020	MBT/Hk Distal
L5/OB	-17°	2°	0°	32-1450-0073	32-1350-0073	32-2450-0073	32-2350-0073	MBT/Offset Base
L5/OB/Hk	-17°	2°	0°	32-145D-0073	32-135D-0073	32-245D-0073	32-235D-0073	MBT/Offset Bs/Hk D
L5	-22°	0°	0°	32-1650-0010	32-1650-0010	32-2650-0010	32-2650-0010	ROTH
L5/Hk	-22°	0°	0°	32-145D-0010	32-135D-0010	32-245D-0010	32-235D-0010	ROTH/Hk Distal
L5/OB	-22°	0°	0°	32-1650-0013	32-1650-0013	32-2650-0013	32-2650-0013	ROTH/Offset Base
L5/OB/Hk	-22°	0°	0°	32-145D-0013	32-135D-0013	32-245D-0013	32-235D-0013	ROTH/Offset Bs/Hk D

LEGEND Medium

LEGEND Medium V-SLOT

CHART IDENTIFICATION
BALL HOOK
OPTION
OFFSET BASE

Maxillary				Part Numbers				Notes
Tooth	Torque	Angulation	Rotation	018R	018L	022R	022L	
U1	12°	5°	0°	32-1110-0034	32-1210-0034	32-2110-0034	32-2210-0034	
U2	8°	9°	0°	32-1120-0034	32-1220-0034	32-2120-0034	32-2220-0034	
U3	-2°	7°	0°	32-1130-0034	32-1230-0034	32-2130-0034	32-2230-0034	
U3/Hk	-2°	7°	0°	32-113D-0034	32-123D-0034	32-213D-0034	32-223D-0034	Hk Distal
U4-5	-7°	0°	0°	32-1540-0034	32-1540-0034	32-2540-0034	32-2540-0034	Universal
U4-5/Hk	-7°	0°	0°	32-114M-0034	32-124M-0034	32-214M-0034	32-224M-0034	Hk Mesial
U4-5/OB	-7°	0°	0°	32-1540-0035	32-1540-0035	32-2540-0035	32-2540-0035	Offset Base/Universal

Mandibular				Part Numbers				Notes
Tooth	Torque	Angulation	Rotation	018R	018L	022R	022L	
L1-2	0°	0°	0°	32-1610-0034	32-1610-0034	32-2610-0034	32-2610-0034	Universal
L1-2 (Opt)	-5°	0°	0°	—	—	32-2610-0036	32-2610-0036	
L3	-5°	7°	0°	32-1430-0034	32-1330-0034	32-2430-0034	32-2330-0034	
L3/Hk	-5°	7°	0°	32-143D-0034	32-133D-0034	32-243D-0034	32-233D-0034	Hk Distal
L4	-11°	0°	0°	32-1640-0034	32-1640-0034	32-2640-0034	32-2640-0034	Universal
L4/Hk	-11°	0°	0°	32-144D-0034	32-134D-0034	32-244D-0034	32-234D-0034	Hk Distal
L5	-17°	0°	0°	32-1650-0034	32-1650-0034	32-2650-0034	32-2650-0034	Universal
L5/Hk	-17°	0°	0°	32-145D-0034	32-135D-0034	32-245D-0034	32-235D-0034	Hk Distal
L4/OB	-11°	0°	0°	32-1640-0035	32-1640-0035	32-2640-0035	32-2640-0035	Offset Base/Universal
L5/OB	-17°	0°	0°	32-1650-0035	32-1650-0035	32-2650-0035	32-2650-0035	Offset Base/Universal

Single Patient Kits				Part Numbers		Notes
Rx	Upper Arch	Lower Arch	Hooks	018	022	
V-Slot	5-5	5-5	3	—	32-2CC3-0034	Hooks on 3's only
V-Slot/OB	5-5	5-5	3	—	32-2CC3-0034	Offset Base 4&5

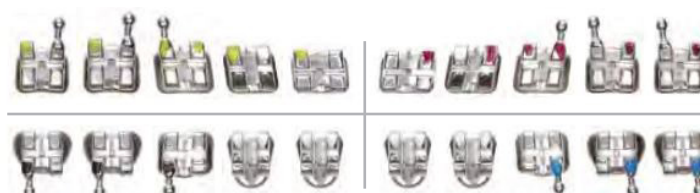

Color Codes

UR	UL
LR	LL



LEGEND Medium V-SLOT Bidimensional

CHART IDENTIFICATION
BALL HOOK
OPTION
OFFSET BASE

Maxillary				Part Numbers				Notes
Tooth	Torque	Angulation	Rotation	018R	018L	022R	022L	
U1	12°	5°	0°	32-1110-0034	32-1210-0034	—	—	
U2	8°	9°	0°	32-1120-0034	32-1220-0034	—	—	
U3	0°	7°	0°	32-1130-0040	32-1230-0040	32-2130-0040	32-2230-0040	
U3/Hk	0°	7°	0°	32-113D-0040	32-123D-0040	32-213D-0040	32-223D-0040	Hk Distal
U4-5	0°	0°	0°	32-1540-0040	32-1540-0040	32-2540-0040	32-2540-0040	Universal
U4-5/Hk	0°	0°	0°	—	—	32-214M-0040	32-224M-0040	Hk Mesial

Mandibular				Part Numbers				Notes
Tooth	Torque	Angulation	Rotation	018R	018L	022R	022L	
L1-2	0°	0°	0°	32-1610-0034	32-1610-0034	—	—	Universal
L3/Hk	0°	5°	0°	32-143D-0040	32-133D-0040	32-243D-0040	32-233D-0040	Hk Distal
L4	0°	0°	0°	—	—	32-2640-0040	32-2640-0040	Universal
L4/Hk	0°	0°	0°	—	—	32-244D-0040	32-234D-0040	Hk Distal
L4-5/OB	0°	0°	0°	32-1640-0041	32-1640-0041	32-2640-0041	32-2640-0041	Offset Base/Universal



Single Patient Kits				Part Numbers		Notes
Rx	Upper Arch	Lower Arch	Hooks	BIDIMENSIONAL		
V-Slot	5-5	5-5	3	32-2CC3-0034		Hooks on 3's only, zero torque 3-5 as above
V-Slot	5-5	5-5	3	32-2CC3-0034		Hooks on 3's only, Bioprogressive 3-5 (as below)

LEGEND Medium V-SLOT Bioprogressive

Maxillary				Part Numbers				Notes
Tooth	Torque	Angulation	Rotation	018R	018L	022R	022L	
U1	22°	5°	0°	32-1110-0028	32-1210-0028	32-2110-0028	32-2210-0028	
U1 (Opt)	17°	5°	0°	32-1110-0029	32-1210-0029	32-2110-0029	32-2210-0029	Option
U2	14°	9°	0°	32-1120-0028	32-1220-0028	32-2120-0028	32-2220-0028	
U3/Hk	7°	5°	0°	32-113D-0028	32-123D-0028	32-213D-0028	32-223D-0028	Hk Distal
U4-5	-7°	0°	0°	32-1540-0029	32-1540-0029	32-2540-0034	32-2540-0034	Universal

Mandibular				Part Numbers				Notes
Tooth	Torque	Angulation	Rotation	018R	018L	022R	022L	
L1-2	0°	0°	0°	32-1610-0034	32-1610-0034	32-2610-0034	32-2610-0034	Universal
L3/Hk	7°	5°	0°	32-143D-0028	32-133D-0028	32-243D-0028	32-233D-0028	Hk Distal
L4	-11°	0°	0°	32-1640-0029	32-1640-0029	—	—	Universal
L5	-17°	0°	0°	32-1650-0029	32-1650-0029	—	—	Universal

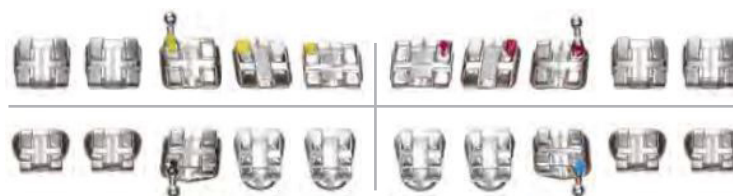

Color Codes



Legacy & Legacy Mini

Legacy & Legacy Mini

Based on Dr. Roth's philosophy, this bracket is the most successful programmed straight wire bracket. In addition to in/out (1st dimension), torque, tip and overcrowding are programmed into the cuspid and bicuspid brackets to correct the effects of parasitic rotations due to positioning mechanics.

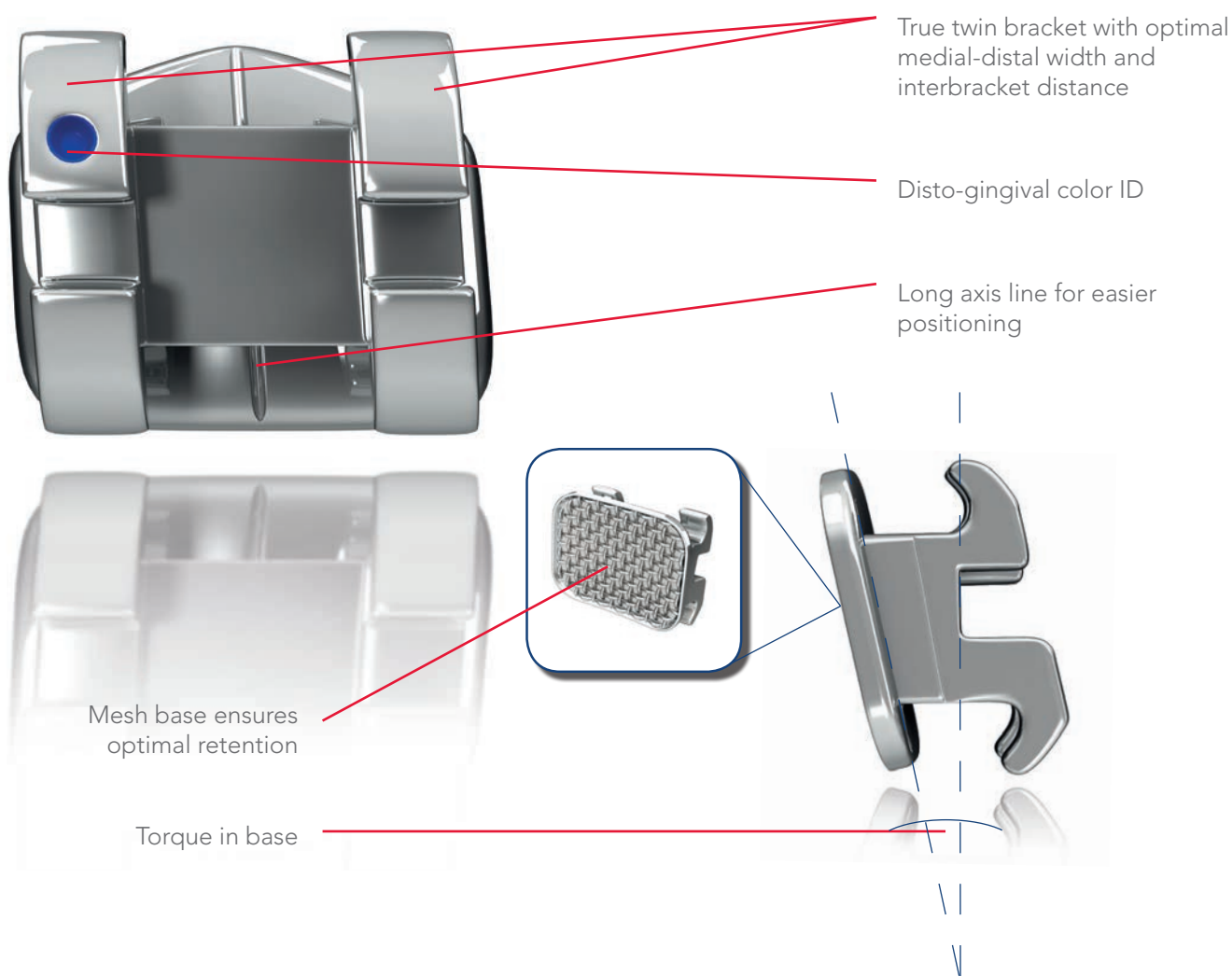

Color Codes

For some prescriptions, the Color Codes may be different on bicuspids.

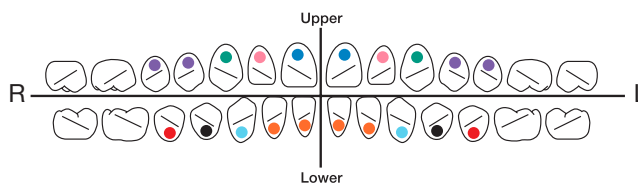

Legacy Mini

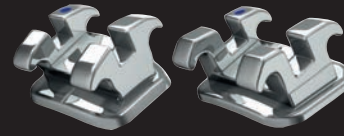

Legacy Mini Roth

CHART IDENTIFICATION

BALL HOOK

OPTION

OFFSET BASE

Maxillary				Part Numbers				Notes
Tooth	Torque	Angulation	Rotation	018R	018L	022R	022L	
U1	12°	5°	0°	27-1110-0010	27-1210-0010	27-2110-0010	27-2210-0010	
U2	8°	9°	0°	27-1120-0010	27-1220-0010	27-2120-0010	27-2220-0010	
U3	-2°	13°	4°m	—	—	27-2130-0010	27-2230-0010	
U3/Hk	-2°	13°	4°m	27-113D-0010	27-123D-0010	27-213D-0010	27-223D-0010	Hk Distal
U3/Hk (Opt)	-2°	9°	4°m	27-113D-0012	27-123D-0012	27-213D-0012	27-223D-0012	Hk Distal
U4-5	-7°	0°	2°d	27-1140-0010	27-1240-0010	27-2140-0010	27-2240-0010	
U4-5/Hk M	-7°	0°	2°d	27-114M-0010	27-124M-0010	27-214M-0010	27-224M-0010	Hk Mesial

Mandibular				Part Numbers				Notes
Tooth	Torque	Angulation	Rotation	018R	018L	022R	022L	
L1-2	-1°	2°	0°	27-1410-0010	27-1310-0010	27-2410-0010	27-2310-0010	
L1-2 (Opt)	-5°	2°	0°	—	—	27-2410-0011	27-2310-0011	Option
L3	-11°	7°	2°m	—	—	27-2430-0010	27-2330-0010	
L3/Hk	-11°	7°	2°m	27-143D-0010	27-133D-0010	27-243D-0010	27-233D-0010	Hk Distal
L4/Hk	-17°	-1°	4°d	—	—	27-244D-0010	27-234D-0010	Hk Distal
L5/Hk	-22°	-1°	4°d	—	—	27-245D-0010	27-235D-0010	Hk Distal
L4/OB	-17°	-1°	4°d	—	—	27-2440-0013	27-2340-0013	Offset Base
L4/OB/Hk	-17°	-1°	4°d	27-144D-0013	27-134D-0013	27-244D-0013	27-234D-0013	Offset Base/Hk Distal
L5/OB	-22°	-1°	4°d	27-1450-0013	27-1350-0013	27-2450-0013	27-2350-0013	Offset Base
L5/OB/Hk	-22°	-1°	4°d	27-145D-0013	27-135D-0013	27-245D-0013	27-235D-0013	Offset Base/Hk Distal

Single Patient Kits				Part Numbers		Notes
Rx	Upper Arch	Lower Arch	Hooks	018	022	
Roth	5-5	5-5	3,4,5	—	27-2CC5-0010	Hooks on 3,4,5

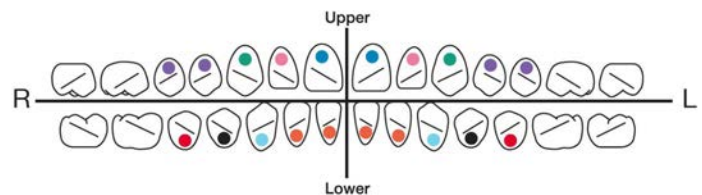

Legacy Roth

CHART IDENTIFICATION
BALL HOOK
OPTION

Maxillary				Part Numbers				Notes
Tooth	Torque	Angulation	Rotation	018R	018L	022R	022L	
U1	12°	5°	0°	—	—	28-2110-0010	28-2210-0010	
U2	8°	9°	0°	—	—	28-2120-0010	28-2220-0010	
U2/Hk	8°	9°	0°	—	—	28-212D-0010	28-222D-0010	Hk Distal
U3	-2°	13°	4°m	—	—	28-2130-0010	28-2230-0010	
U3/Hk	-2°	13°	4°m	—	—	28-213D-0010	28-223D-0010	Hk Distal
U3 (Opt)	-2°	9°	4°m	—	—	28-2130-0012	28-2230-0012	Hk Distal
U3/Hk (Opt)	-2°	9°	4°m	—	—	28-213D-0012	28-223D-0012	Hk Distal
U4-5	-7°	0°	2°d	28-1140-0010	28-1240-0010	28-2140-0010	28-2240-0010	
U4-5/Hk M	-7°	0°	2°d	—	—	28-214M-0010	28-224M-0010	Hk Mesial
U4-5/Hk D	-7°	0°	2°d	—	—	28-214D-0010	28-224D-0010	Hk Distal

Mandibular				Part Numbers				Notes
Tooth	Torque	Angulation	Rotation	018R	018L	022R	022L	
L1-2	-1°	2°	0°	—	—	28-2410-0010	28-2310-0010	
L3	-11°	7°	2°m	—	—	28-2430-0010	28-2330-0010	
L3/Hk	-11°	7°	2°m	—	—	28-243D-0010	28-233D-0010	Hk Distal
L4	-17°	-1°	4°d	28-1440-0010	28-1340-0010	28-2440-0010	28-2340-0010	
L4/Hk	-17°	-1°	4°d	28-144D-0010	28-134D-0010	28-244D-0010	28-234D-0010	Hk Distal
L5	-22°	-1°	4°d	28-1450-0010	28-1350-0010	28-2450-0010	28-2350-0010	
L5/Hk	-22°	-1°	4°d	—	—	28-245D-0010	28-235D-0010	Hk Distal

Single Patient Kits				Part Numbers			Notes
Rx	Upper Arch	Lower Arch	Hooks	018	022		
Roth	5-5	5-5	3,4,5	—	28-2CC5-0010		Hooks on 3,4,5

Legacy Roth XT (Extra Torque)

Maxillary				Part Numbers				Notes
Tooth	Torque	Angulation	Rotation	018R	018L	022R	022L	
U1 (XT)	17°	5°	0°	—	—	28-2110-0011	28-2210-0011	
U2 (XT)	10°	9°	0°	—	—	28-2120-0011	28-2220-0011	
U3 (XT)	3°	9°	4°m	—	—	28-2130-0011	28-2230-0011	
U3/Hk (XT)	3°	9°	4°m	—	—	28-213D-0011	28-223D-0011	Hk Distal

Mandibular				Part Numbers				Notes
Tooth	Torque	Angulation	Rotation	018R	018L	022R	022L	
L3/Hk (XT)	0°	5°	0°	—	—	28-243D-0011	28-233D-0011	Hk Distal

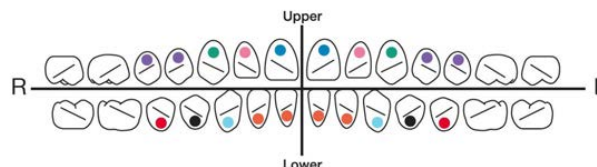



AXCESS

AXCESS, also manufactured by Tomy® in Japan, is an affordable bracket created from MIM (Metal Injection Molded) technology. All information (3 dimensions) is built into the bracket. Torque in base system. A laser-milled anatomical base guarantees retention as reliable as found in traditional meshes.

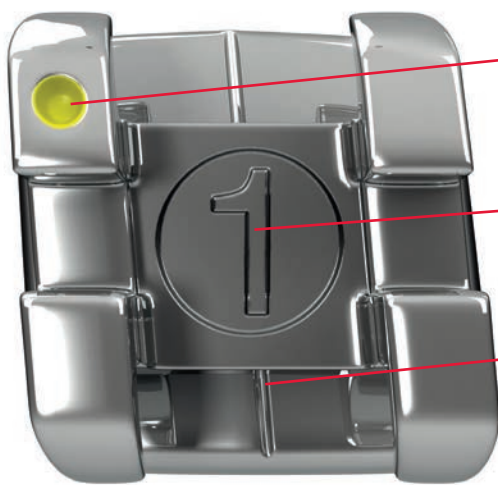

Disto-gingival color ID

Tooth identification

Rhomboid shaped bracket with axis line for ideal positioning

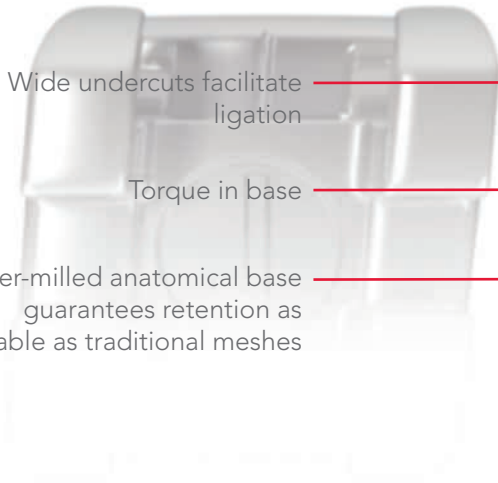

Wide undercuts facilitate ligation

Torque in base

Laser-milled anatomical base guarantees retention as reliable as traditional meshes



Color Codes

Disto-gingival color coding allows for quick bracket identification and bonding accuracy.

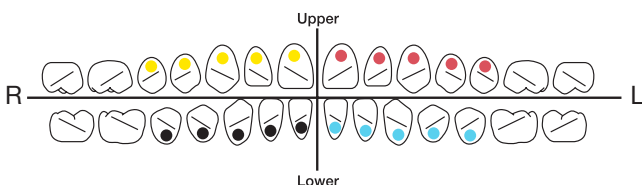

Color Codes



AXCESS

AXCESS Roth

CHART IDENTIFICATION
BALL HOOK
OPTION
OFFSET BASE

Maxillary				Part Numbers				Notes
Tooth	Torque	Angulation	Rotation	018R	018L	022R	022L	
U1	12°	5°	0°	30-1110-0010	30-1210-0010	30-2110-0010	30-2210-0010	
U2	8°	9°	0°	30-1120-0010	30-1220-0010	30-2120-0010	30-2220-0010	
U3/Hk	-2°	13°	0°	30-113D-0010	30-123D-0010	30-213D-0010	30-223D-0010	Hk Distal
U3/Hk (Opt)	0°	13°	0°	—	—	30-213D-0014	30-223D-0014	Hk Distal
U4-5	-7°	0°	0°	30-1540-0010	30-1540-0010	30-2540-0010	30-2540-0010	Universal
U4-5/Hk M	-7°	0°	0°	30-114M-0010	30-124M-0010	30-214M-0010	30-224M-0010	Hk Mesial

Mandibular				Part Numbers				Notes
Tooth	Torque	Angulation	Rotation	018R	018L	022R	022L	
L1-2	-1°	0°	0°	30-1610-0010	30-1610-0010	30-2610-0010	30-2610-0010	Universal
L3/Hk	-11°	7°	0°	30-143D-0010	30-133D-0010	30-243D-0010	30-233D-0010	Hk Distal
L3/Hk (Opt)	-11°	9°	0°	—	—	30-243D-0014	30-233D-0014	Hk Distal
L4/Hk	-17°	0°	0°	30-144D-0010	30-134D-0010	30-244D-0010	30-234D-0010	Hk Distal
L5/Hk	-22°	0°	0°	30-145D-0010	30-135D-0010	30-245D-0010	30-235D-0010	Hk Distal
L4/OB	-17°	0°	0°	30-1640-0013	30-1640-0013	30-2640-0013	30-2640-0013	Offset Base/Universal
L5/OB	-22°	0°	0°	30-1650-0013	30-1650-0013	30-2650-0013	30-2650-0013	Offset Base/Universal

AXCESS MBT

Maxillary				Part Numbers				Notes
Tooth	Torque	Angulation	Rotation	018R	018L	022R	022L	
U1	12°	5°	0°	—	—	30-2110-0020	30-2210-0020	
U2	8°	9°	0°	—	—	30-2120-0020	30-2220-0020	
U3/Hk	-2°	13°	0°	—	—	30-213D-0020	30-223D-0020	Hk Distal
U4-5	-7°	0°	0°	—	—	30-2540-0010	30-2540-0010	Universal
U4/Hk D	-7°	0°	0°	—	—	30-214D-0020	30-224D-0020	Hk Mesial
U5/Hk D	-7°	0°	0°	—	—	30-215D-0020	30-225D-0020	Hk Mesial

Mandibular				Part Numbers				Notes
Tooth	Torque	Angulation	Rotation	018R	018L	022R	022L	
L1-2	-6°	0°	0°	—	—	30-2610-0020	30-2610-0020	Universal
L3/Hk	-11°	7°	0°	—	—	30-243D-0020	30-233D-0020	Hk Distal
L4/Hk	-17°	0°	0°	—	—	30-244D-0020	30-234D-0020	Hk Distal
L5/Hk	-22°	0°	0°	—	—	30-245D-0020	30-235D-0020	Hk Distal

Single Patient Kits				Part Numbers		Notes
Rx	Upper Arch	Lower Arch	Hooks	018	022	
Roth	5-5	5-5	3	—	30-2CC3-0010	Hooks on 3's only
Roth	5-5	5-5	3,4,5	30-1CC5-0010	30-2CC5-0010	Hooks on 3,4,5
MBT	5-5	5-5	3,4,5	—	30-2CC5-0020	Hooks on 3,4,5

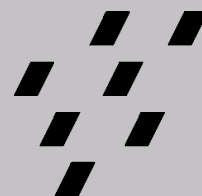

Standard Edgewise

Standard Edgewise

		Width	Part Numbers		Notes
		mm	.018	.022	
	Upper Centrals				
	Double extra-wide	4.0	29-1510-0062	29-2510-0062	extra-wide
	Double wide	3.2	29-1510-0059	29-2510-0059	wide
	Upper Laterals				
	Double medium	2.6	29-1520-0053	29-2520-0053	medium
	Double wide	3.2	—	29-2520-0059	wide
	Upper and Lower Cuspids				
	Double wide	4.0	29-1730-0059	29-2730-0059	wide
	Double medium	2.6	29-1730-0053	29-2730-0053	medium
	Double wide	2.6	29-1630-0054	—	low profile
	Wide, hook, UR/LL	3.2	29-163D-0059	29-263D-0059	UR/LL w/hook
	Wide, hook, UL/LR	3.2	29-153D-0059	29-253D-0059	UL/LR w/hook
	Upper Bicuspids				
	Offset wing, wide	3.2	29-1540-0061	—	offset, wide
	Offset wing, medium	2.6	29-1540-0057	29-2540-0057	offset, medium
	Offset wing, narrow	2.1	—	29-2540-0052	offset, narrow
	Narrow	2.1	—	29-2740-0050	narrow
	Medium	2.6	29-1740-0053	29-2740-0053	medium
	Upper/Lower Molars				
	Extra-wide	4.0	29-1760-0062	29-2760-0062	extra-wide
	Wide	3.2	29-1760-0059	29-2760-0059	wide
	Lower Anteriors				
	Double, low profile, narrow	2.1	29-1610-0051	29-2610-0051	low profile, narrow
	Double, low profile, medium	2.6	29-1610-0055	29-2610-0055	low profile, medium
	Double, standard narrow	2.1	29-1610-0050	29-2610-0050	standard, narrow
	Double, standard medium	2.6	—	29-2610-0053	standard, medium
	Double, standard wide	2.6	—	29-2610-0059	standard, 162 wide
	Lower Bicuspids				
	Low profile, medium	2.6	29-1640-0055	29-2640-0055	low profile, medium
	Low profile, med, kidney-shaped	2.6	—	29-2640-0058	LP, M, kidney-shaped
	Low profile, narrow	2.1	—	29-2640-0051	low profile, narrow

Standard Edgewise

Standard Edgewise V-Slot

		Width	Part Numbers		Notes
		mm	.018	.022	
	Upper Centrals				
	Double extra-wide	4.0	—	36-2510-0062	extra-wide
	Wide twin	3.2	36-1510-0059	36-2510-0059	wide
	Upper Laterals				
	Double medium	2.6	36-1520-0053	36-2520-0053	medium
	Upper and Lower Cuspids				
	Wide twin	3.2	36-1730-0059	36-2730-0059	wide
	Medium twin	2.6	36-1730-0053	36-2730-0053	medium
	Upper and Lower Bicuspid				
	Offset wing, medium twin	2.6	36-1540-0057	36-2540-0057	offset, medium
	Low profile, medium	2.6	36-1640-0055	36-2640-0055	low profile, medium
	Standard medium	2.1	36-1740-0053	36-2740-0053	standard, medium
	Standard wide	2.1	—	36-2740-0059	standard, wide
	Upper/Lower Molars				
	Extra-wide	4.0	36-1760-0062	—	extra-wide
	Wide	3.2	36-1760-0059	36-2760-0059	wide
	Lower Anteriors				
	Low profile, narrow	2.1	36-1610-0051	36-2610-0051	low profile, narrow
	Low profile, medium	2.6	36-1610-0055	—	low profile, medium
	Standard narrow	2.1	36-1610-0050	—	standard, narrow
	Standard medium	2.6	36-1610-0053	36-2610-0053	standard, medium
	Standard medium	2.6	26-1610-0034	—	standard, medium

Begg Style Brackets

	Description	Slot	Part Numbers	Notes
	U/L 1-2 Flat	.030	35-7710-0000	U/L 1-2 Flat
	U/L 3-4-5 Curved	.030	35-7730-0000	U/L 3-4-5 Curved

Weldable Brackets

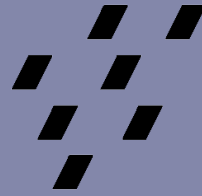

Weldable Brackets - LEGEND Mini



Maxillary				Part Numbers				Notes
Tooth	Torque	Angulation	Rotation	018R	018L	022R	022L	
U4-5	-7°	0°	0°	34-1540-0010	34-1540-0010	34-2540-0010	34-2540-0010	Universal
U4-5/Hk	-7°	0°	0°	34-114M-0010	34-124M-0010	34-214M-0010	34-224M-0010	Hk Mesial

Mandibular

Tooth	Torque	Angulation	Rotation	018R	018L	022R	022L	Notes
L4/Hk	-17°	0°	0°	34-144D-0010	34-134D-0010	34-244D-0010	34-234D-0010	Hk Distal
L5	-22°	0°	0°	—	—	34-2650-0010	34-2650-0010	Universal
L5/Hk	-22°	0°	0°	34-145D-0010	34-135D-0010	34-245D-0010	34-235D-0010	Hk Distal

Weldable Brackets - LEGEND Medium



Maxillary				Part Numbers				Notes
Tooth	Torque	Angulation	Rotation	018R	018L	022R	022L	
U4-5	-7°	0°	0°	33-1540-0010	33-1540-0010	33-2540-0010	33-2540-0010	Universal
U4-5/Hk	-7°	0°	0°	33-114M-0010	33-124M-0010	33-214M-0010	33-224M-0010	Hk Mesial

Mandibular

Tooth	Torque	Angulation	Rotation	018R	018L	022R	022L	Notes
L4	-17°	0°	0°	33-1640-0010	33-1640-0010	33-2640-0010	33-2640-0010	Hk Distal
L4/Hk	-17°	0°	0°	33-144D-0010	33-134D-0010	33-244D-0010	33-234D-0010	Hk Distal
L5	-22°	0°	0°	33-1650-0010	33-1650-0010	33-2650-0010	33-2650-0010	Universal
L5/Hk	-22°	0°	0°	33-145D-0010	33-135D-0010	33-245D-0010	33-235D-0010	Hk Distal

Weldable Brackets - LEGEND Mini & Medium V-Slot



Maxillary				Part Numbers				Notes
Tooth	Torque	Angulation	Rotation	018R	018L	022R	022L	
U4-5/Hk V-S	-7°	0°	0°	—	—	34-214M-0034	33-224M-0034	Mini V-Slot/Hk Mesial
U4-5/V-S	-7°	0°	0°	33-1540-0034	33-1540-0034	33-2540-0034	33-2540-0034	Univ/Medium V-Slot

Mandibular

Tooth	Torque	Angulation	Rotation	018R	018L	022R	022L	Notes
L4/V-Slot	-11°	0°	0°	33-1640-0034	33-1640-0034	33-2640-0034	33-2640-0034	Univ/Medium V-Slot
L5/V-Slot	-17°	0°	0°	33-1650-0034	33-1650-0034	33-2650-0034	33-2650-0034	Univ/Medium V-Slot

Weldable Brackets - LEGACY



Maxillary				Part Numbers				Notes
Tooth	Torque	Angulation	Rotation	018R	018L	022R	022L	
U4-5/Hk	-7°	0°	2°d	—	—	23-214D-0010	23-224D-0010	Hk Distal

Mandibular

Tooth	Torque	Angulation	Rotation	018R	018L	022R	022L	Notes
L4/Hk	-17°	-1°	4°d	—	—	23-244D-0010	23-234D-0010	Hk Distal
L5/Hk	-22°	-1°	4°d	—	—	23-245D-0010	23-235D-0010	Hk Distal

Weldable Brackets - Experience Metal Self-Ligating



Maxillary				Part Numbers				Notes
Tooth	Torque	Angulation	Rotation	018R	018L	022R	022L	
U4-5/Hk	-7°	0°	0°	22-114D-0010	22-124D-0010	22-214D-0010	22-224D-0010	Hk Mesial

Mandibular

Tooth	Torque	Angulation	Rotation	018R	018L	022R	022L	Notes
L5/Hk	-22°	-1°	4°d	22-145D-0010	22-135D-0010	22-245D-0010	22-235D-0010	Hk Distal

